

User Guide
6617-2203

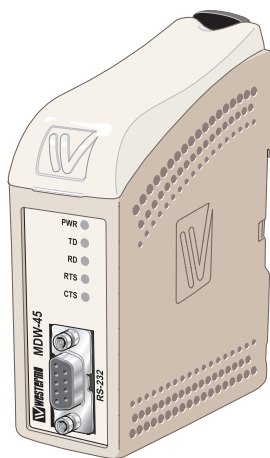

MDW-45



Converter
RS-232 – RS-422/485

www.westermo.com



Software tools

Related software tools are available in the folder software tools under technical support on the Westermo website.

License Information

This device contains public available software which is under the GPL license. For more information see legal.pdf included with all firmware releases.

This product includes software developed by the OpenSSL Project for use in the OpenSSL Toolkit. <http://www.openssl.org>

Legal information

The contents of this document are provided "as is". Except as required by applicable law, no warranties of any kind, either express or implied, including, but not limited to, the implied warranties of merchantability and fitness for a particular purpose, are made in relation to the accuracy and reliability or contents of this document. Westermo reserves the right to revise this document or withdraw it at any time without prior notice.

Under no circumstances shall Westermo be responsible for any loss of data or income or any special, incidental, and consequential or indirect damages howsoever caused. More information about Westermo can be found at the following Internet address:

<http://www.westermo.com>

Safety



Before using this unit:

Read this manual completely and gather all information on the unit. Make sure that you understand it fully. Check that your application does not exceed the safe operating specifications for this unit.

Hazardous voltage may occur within this unit when connected to power supply or TNV circuits.

Prevent access to hazardous voltage by disconnecting the unit from power supply and all other electrical connections.

Prevent damage to internal electronics from electrostatic discharges (ESD) by discharging your body to a grounding point (e.g. use of wrist strap).



Before installation:

This unit should only be installed by qualified personnel.

This unit should be built-in to an apparatus cabinet, or similar, where access is restricted to service personnel only.

The power supply wiring must be sufficiently fused, and if necessary it must be possible to disconnect manually from the power supply. Ensure compliance to national installation regulations.

This unit uses convection cooling. To avoid obstructing the airflow around the unit, follow the spacing recommendations (see Installation section).

Care recommendations

Follow the care recommendations below to maintain full operation of unit and to fulfil the warranty obligations.

This unit must not be operating with removed covers or lids.

Do not attempt to disassemble the unit. There are no user serviceable parts inside.

Do not drop, knock or shake the unit, rough handling above the specification may cause damage to internal circuit boards.

Do not use harsh chemicals, cleaning solvents or strong detergents to clean the unit.

Do not paint the unit. Paint can clog the unit and prevent proper operation.

Do not expose the unit to any kind of liquids (rain, beverages, etc). The unit is not waterproof. Keep the unit within the specified humidity levels.

Do not use or store the unit in dusty, dirty areas, connectors as well as other mechanical part may be damaged.

If the unit is not working properly, contact the place of purchase, nearest Westermo distributor office or Westermo Tech support.

Maintenance

No maintenance is required, as long as the unit is used as intended within the specified conditions.

Agency approvals and standards compliance

Type	Approval / Compliance	
EMC	EN 50121-4	Railway signalling and telecommunications apparatus
	EN 61000-6-1	Immunity residential environments
	EN 61000-6-2	Immunity industrial environments
	EN 61000-6-3	Emission residential environments
	EN 61000-6-4	Emission industrial environments
	FCC part 15	Class B
	IEC 62236-4	Railway signalling and telecommunications apparatus
Safety	EN/IEC 60950-1	IT equipment

FCC Part 15.105 Notice:

This equipment has been tested and found to comply with the limits for a Class B digital device, pursuant to Part 15 of the FCC Rules. These limits are designed to provide reasonable protection against harmful interference in a residential installation. This equipment generates, uses and can radiate radio frequency energy and, if not installed and used in accordance with the instructions, may cause harmful interference to radio communications. However, there is no guarantee that interference will not occur in a particular installation. If this equipment does cause harmful interference to radio or television reception, which can be determined by turning the equipment off and on, the user is encouraged to try to correct the interference by one or more of the following measures:

- ⌘ Reorient or relocate the receiving antenna.
- ⌘ Increase the separation between the equipment and receiver.
- ⌘ Connect the equipment into an outlet on a circuit different from that to which the receiver is connected.
- ⌘ Consult the dealer or an experienced radio/TV technician for help.

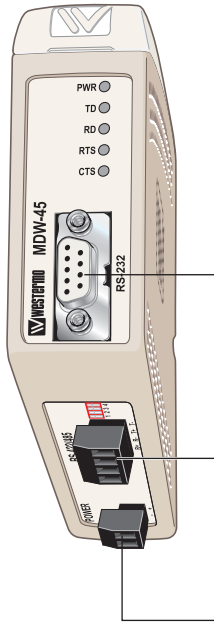

RS-232

Position	Direction* / description	Input /Output values
1	Not connected	$U_{\max} = \pm 12 \text{ Vpk}$ $I_{\max} = \pm 60 \text{ mA}$ Data rate: 1.2 – 115.2 kbit/s
2	Out / Received Data (RD)	
3	In / Transmitted Data (TD)	
4	Not connected	
5	– / Signal Ground (SG)	
6	Out / Data Set Ready (DSR)	
7	In / Request To Send (RTS)	
8	Out / Clear To Send (CTS)	
9	Not connected	

RS-422/485

Position	Direction* / description	Input /Output values
1	In / R+ line RS-422	$U_{\max} = \pm 5 \text{ Vpk}$ $I_{\max} = \pm 250 \text{ mA}$ Data rate: 1.2 – 115.2 kbit/s
2	In / R– line RS-422	
3	In / Out / T+ line RS-422/485	
4	In / Out / T– line RS-422/485	

Power – LV

Position	Direction* / description	Input values
1	In / COM	$U_{\text{in}} = 9.6 - 57.6 \text{ VDC}$ $\text{Max}_{\text{in}} = 0.16 \text{ A @ } 9.6 \text{ VDC}$ $P_{\text{In}} = 2 \text{ W}$
2	In / +VA	
3	In / +Voltage B	
4	In / Common	
Galvanically isolated via power transformer and optocoupler. Capacitively isolated via Y1 capacitor rated 440 Vrms 3300 pF.		

Declaration of Conformity, Low Voltage



Westermo Teleindustri AB

Declaration of conformity

The manufacturer Westermo Teleindustri AB
SE-640 40 Stora Sundby, Sweden

Herewith declares that the product(s)

Type of product	Model	Art no
RS-232 – RS-422/485 Converter	MDW-45 LV	3617-0001

is in conformity with the following EC directive(s).

No	Short name
2004/108/EC	Electromagnetic Compatibility (EMC)
2011/65/EU	Restriction of the use of certain hazardous substances in electrical and electronic equipment (RoHS)

References of standards applied for this EC declaration of conformity.

No	Title	Issue
EN 61000-6-1	Electromagnetic compatibility – Immunity for residential environments	2007
EN 61000-6-2	Electromagnetic compatibility – Immunity for industrial environments	2005
EN 61000-6-3	Electromagnetic compatibility – Emission for residential environments	2007 +A1: 2011
EN 61000-6-4	Electromagnetic compatibility – Emission for industrial environments	2007 +A1:2011
EN 50121-4	Railway applications - Electromagnetic compatibility Emission and immunity of the signalling and telecommunications apparatus	2006
EN 50581	Technical documentation for the assessment of electrical and electronic products with respect to the restriction of hazardous substances	2012

The last two digits of the year in which the CE marking was affixed: 15

Signature

Pierre Öberg
Technical Manager
6th August 2015

Postadress/Postal address	Tel.	Telefax	Postgiro	Bankgiro	Org.nr/ Corp. identity number	Registered office
S-640 40 Stora Sundby Sweden	016-428000 Int+46 16428000	016-428001 Int+46 16428001	52 72 79-4	5671-5550	556361-2604	Eskilstuna

Declaration of Conformity, High Voltage



Westermo Teleindustri AB

Declaration of conformity

The manufacturer Westermo Teleindustri AB
SE-640 40 Stora Sundby, Sweden

Herewith declares that the product(s)

Type of product	Model	Art no
RS-232 – RS-422/485 Converter	MDW-45 HV	3617-0101

is in conformity with the following EC directive(s).

No	Short name
2004/108/EC	Electromagnetic Compatibility (EMC)
2006/95/EC	Low Voltage (LVD)
2011/65/EU	Restriction of the use of certain hazardous substances in electrical and electronic equipment (RoHS)

References of standards applied for this EC declaration of conformity.

No	Title	Issue
EN 61000-6-1	Electromagnetic compatibility – Immunity for residential environments	2007
EN 61000-6-2	Electromagnetic compatibility – Immunity for industrial environments	2005
EN 61000-6-3	Electromagnetic compatibility – Emission for residential environments	2007 +A1: 2011
EN 61000-6-4	Electromagnetic compatibility – Emission for industrial environments	2007 +A1:2011
EN 50121-4	Railway applications - Electromagnetic compatibility Emission and immunity of the signalling and telecommunications apparatus	2006
EN 60950-1	Information technology equipment -- Safety -- General requirements	2006 +A11:2009 +A1: 2010 +A12:2011 +A2: 2013
EN 50581	Technical documentation for the assessment of electrical and electronic products with respect to the restriction of hazardous substances	2012

The last two digits of the year in which the CE marking was affixed:

15

Signature

Pierre Öberg
Technical Manager
6th August 2015

Postaddress/Postal address
S-640 40 Stora Sundby
Sweden

Tel.
016-428000
Int+46 16428000

Telefax
016-428001
Int+46 16428001

Postgiro
52 72 79-4

Bankgiro
5671-5550

Org.nr/
Corp. identity number
556361-2604

Registered office
Eskilstuna

Type tests and environmental conditions

Electromagnetic Compatibility			
Phenomena	Test	Description	Level
ESD	EN 61000-4-2	Enclosure contact	± 6 kV
		Enclosure air	± 8 kV
RF field AM modulated	IEC 61000-4-3	Enclosure	10 V/m 80% AM (1 kHz), 80 – 1 000 MHz 20 V/m 80% AM (1 kHz), 800 – 960 MHz 20 V/m 80% AM (1 kHz), 1 400 – 2 700 MHz
RF field 900 MHz	ENV 50204	Enclosure	20 V/m pulse modulated 200 Hz, 900 ± 5 MHz
Fast transient	EN 61000-4-4	Signal ports	± 2 kV
		Power ports	± 2 kV
Surge	EN 61000-4-5	Signal ports unbalanced	± 2 kV line to earth, ± 2 kV line to line
		Signal ports balanced	± 2 kV line to earth, ± 1 kV line to line
		Power ports	± 2 kV line to earth, ± 2 kV line to line
RF conducted	EN 61000-4-6	Signal ports	10V 80% AM (1 kHz), 0,15 – 80 MHz
		Power ports	10V 80% AM (1 kHz), 0,15 – 80 MHz
Magnetic field, power freq.	EN 61000-4-8	Enclosure	100 A/m, 50 Hz, 16,7 Hz & 0 Hz
Pulse Magnetic field	EN 61000-4-9	Enclosure	300 A/m, 6,4 / 16 ms pulse
Voltage dips and interruption	EN 61000-4-11	AC power ports	10, 20 & 5000 ms, interruptions 10 & 500 ms, 30% reduction 100, 200 & 1 000 ms, 60% reduction
Mains freq. 50 Hz	EN 61000-4-16	Signal ports	100V 50 Hz
Mains freq. 50 Hz	SS 436 15 03	Signal ports	250V 50 Hz
Voltage dips and interruption	EN 61000-4-29	DC power ports	10 & 100 ms, interruption 10 ms, 30% reduction 10 ms, 60% reduction +20% above & -20% below rated voltage
Radiated emission	EN 55022	Enclosure	Class B
	FCC part 15		Class B
Conducted emission	EN 55022	AC power ports	Class B
	FCC part 15	AC power ports	Class B
	EN 55022	DC power ports	Class B
Dielectric strength		Signal port to all other	2 kVrms 50 Hz 1min
		Power port to all other	3 kVrms 50 Hz 1min 2 kVrms 50 Hz 1min (@ rated power < 60V)
Environmental			
Temperature		Operating	-40 to +70°C
		Storage & Transport	-40 to +70°C
Humidity		Operating	5 to 95% relative humidity
		Storage & Transport	5 to 95% relative humidity
Altitude		Operating	2 000 m / 70 kPa
Service life		Operating	10 year
Vibration	IEC 60068-2-6	Operating	7,5 mm, 5 – 8 Hz 2 g, 8 – 500 Hz
Shock	IEC 60068-2-27	Operating	15 g, 11 ms
Packaging			
Enclosure, MDW-45	UL 94	PC / ABS	Flammability class V-1
Dimension W x H x D			35 x 121 x 119 mm
Weight			0.19 kg
Degree of protection	IEC 529	Enclosure	IP 21
Cooling			Convection
Mounting			Horizontal on 35 mm DIN-rail

Functional description

The MDW-45 is an RS-422/485 to RS-232 converter. This device can be used in multidrop and point to point applications to connect devices like PCs, PLCs, drives and other automation equipment.

In 2-wire half duplex applications (RS-485) the MDW-45 can automatically control the state of the data bus based just on the data it receives. This allows the unit to be used with equipment that has no handshaking signal. The maximum transmission rate possible is 115.2 kbit/s.

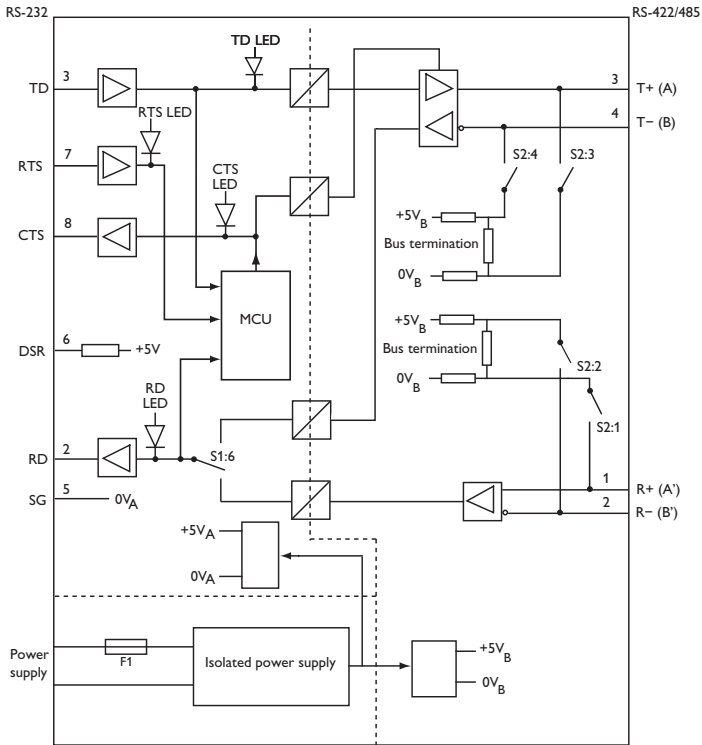

Interface specifications

Power		
	MDW-45 LV	MDW-45 HV
Rated voltage	12 to 48 VDC	95 to 240 VAC 110 to 250 VDC
Operating voltage	9.6 to 57.6 VDC	85.5 to 264 VAC 88 to 300 VDC
Rated current	95 mA @ 12 VDC 35 mA @ 48 VDC	21 mA @ 95 VAC 10 mA @ 110 VDC
Rated frequency	DC	48 – 62 Hz / DC
Polarity	Reverse polarity protected	Polarity independent
Connection	Detachable screw terminal	Detachable screw terminal
Connector size	0.2 – 2.5 mm ² (AWG 24-12)	0.2 – 2.5 mm ² (AWG 24-12)

RS-422/485	
Electrical specification	RS-485
Data rate	1 200 bit/s – 115.2 kbit/s
Data format	7 or 8 data bit, Odd, even or none parity, 1 or 2 stop bit
Connection	Detachable screw terminal
Connector size	0.2 – 2.5 mm ² (AWG 24-12)
Transmission range	In accordance with EIA RS-485 ≤ 1200 m, depending on data rate and cable type
Settings	120 Ω termination and failsafe biasing 680 Ω , by DIP-switch
Protection	Installation Fault Tolerant (up to ±60 V)

RS-232	
Electrical specification	RS-232
Data rate	1 200 bit/s – 115.2 kbit/s
Data format	7 or 8 data bit, Odd, even or none parity, 1 or 2 stop bit
Connection	9-pin D-sub female DCE
Transmission range	15 m

Locations of Interface ports, LED`s and DIP-switches

S1 DIP-switch under lid
(for details see page 10)

LED indicators
(for details see page 8)

S2 DIP-switch
Termination
(for details see page 11)

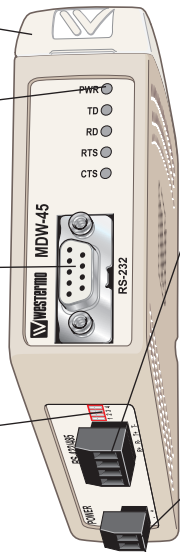

RS-422/485 interface screw terminal

4-position	Direction*	Description
No. 1	In	R+ (A') line RS-422
No. 2	In	R- (B') line RS-422
No. 3	In/Out	T+ (A) line RS-422/485
No. 4	In/Out	T- (B) line RS-422/485

Power connection, LV

2-position	Description
No. 1	0 VDC
No. 2	12 – 48 VDC

Power connection, HV screw terminal

2-position	Description	Product marking
No. 1	AC: Neutral DC: -Voltage	N/-
No. 2	AC: Line DC: +Voltage	L/+

RS-232 (DCE)

9-position	Direction	Description
No. 1	-	
No. 2	Out	Received Data (RD)
No. 3	In	Transmitted Data (TD)
No. 4	-	
No. 5	-	Signal Ground (SG)
No. 6	Out	Data Set Ready (DSR)
No. 7	In	Request To Send (RTS)
No. 8	Out	Clear To Send (CTS)
No. 9	-	

Railway installation close to the rails (RS-232, RS-422/485)

For a cable located inside 3 m boundary and connected to this port, the use of shielded cable is recommended, this to minimize the risk of interference. The cable shield should be properly connected (360°) to an earthing point within 1 m from this port. This earthing point should have a low impedance connection to the conductive enclosure of the apparatus cabinet, or similar, where the unit is built-in. This conductive enclosure should be connected to the earthing system of an installation and may be directly connected to the protective earth.

LED Indicators

LED	Status	Description
PWR	ON	In service
	OFF	Out of service
TD	ON	Transmitted Data: Displays data received from the local RS-232 port
	OFF	No data
RD	ON	Received Data: Displays data leaving the modem on the RS-232 port
	OFF	No data
RTS	ON	Status of RTS from the RS-232 interface
	OFF	No RTS
CTS	ON	Status of CTS from the RS-232 interface
	OFF	No CTS

PWR 

TD 

RD 

RTS 

CTS 

DIP-switch settings



Before DIP-switch settings:

Prevent damage to internal electronics from electrostatic discharges (ESD) by discharging your body to a grounding point (e.g. use of wrist strap).

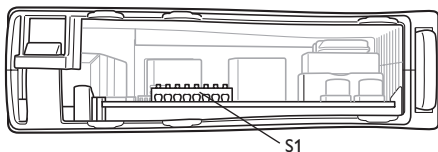

Selection of data rate

S1 1200 bit/s

S1 2400 bit/s

S1 4800 bit/s

S1 9600 bit/s

S1 19.2 kbit/s

S1 38.4 kbit/s

S1 57.6 kbit/s

S1 115.2 kbit/s

Selection of data format

S1 9 bit format*

S1 10 bit format*

S1 11 bit format*

S1 12 bit format*

Supervision table when selecting data format

7 bit	●	●	●		●			
8 bit				●		●	●	●
No parity	●	●		●		●		
Parity			●		●		●	●
1 stop bit	●		●	●			●	
2 stop bit		●			●	●		●
Number of bit	9	10	10	10	11	11	11	12

* See Supervision table when selecting data bits. Turning time 1 – 1.5 bit time

Selection of bus format

S1 2-wire RS-485

S1 4-wire RS-422

Selection of bus control

S1 Data control

S1 RTS-control

S1 Transmitter always active

In RTS-control and Transmitter always active. The switches for data rate and number of bits has no effects.

S2 Below panel, RS-422/485 termination



No termination and fail-safe



Termination with fail-safe (2-wire)



Termination with fail-safe (4-wire)

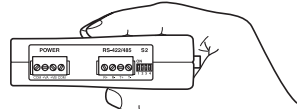

Note! DIP-switch alterations are only effective after a power on.

Factory settings

S1

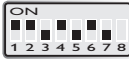

Data rate – 9600 bit/s, data format – 10 bit
Bus format, 2-wire

Note: Switch 1:8 is not used

S2



No termination
and fail-safe

Unit specific description

When the converter is set to data-control mode the transmitter is activated by data on TD (RS-232). The time the transmitter stays active corresponds to one character-time plus the turning time for the set data rate and number of bits. If more data arrives on TD before the turning time has expired the transmitter stays active for an additional one character time and so on. In RTS-control mode the transmitter is activated by the RS-232 RTS-signal. In this mode the dip-switches for data rate and number of bits have no effect. The LED indicators show the status of the data signals. The fail-safe termination ensures that the signal level at the receiver is in 'mark state' (differential > 0.2 Volts) when there is no data on the RS-485 bus. Full duplex is only possible if 4-wires are used.

Field of application

RS-422 and RS-485 were both designed for multidrop applications. When a system is installed it should always form a bus structure (see diagrams). Star shaped networks should never be created; there are other Westermo products that can be used to create star net applications. To install a system according to the RS-422/485 specification it is very important that the line is terminated at the correct points. The recommendation is to terminate the receiver on the master unit and the final bus slave unit. See diagrams for details of how this is done with RS-485 (2-wire) and RS-422 (4-wire).

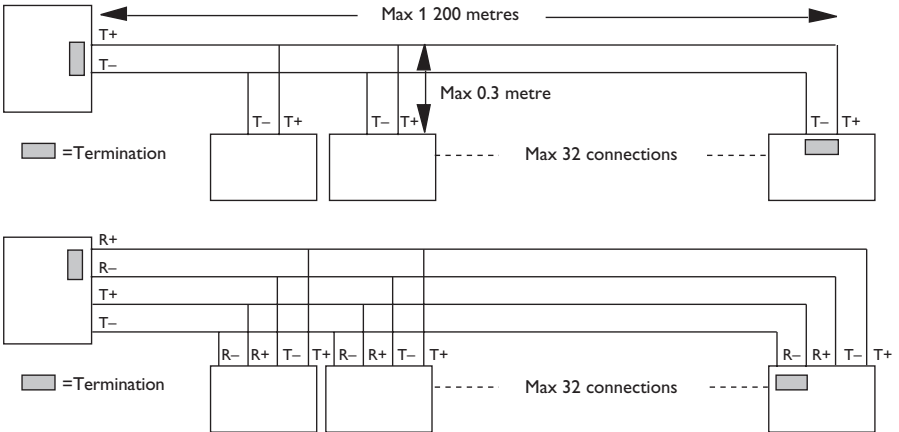

N.B. R+/R-, T+/T- definitions are not standard, it can help to shift + and - if the unit does not work.

Line connection

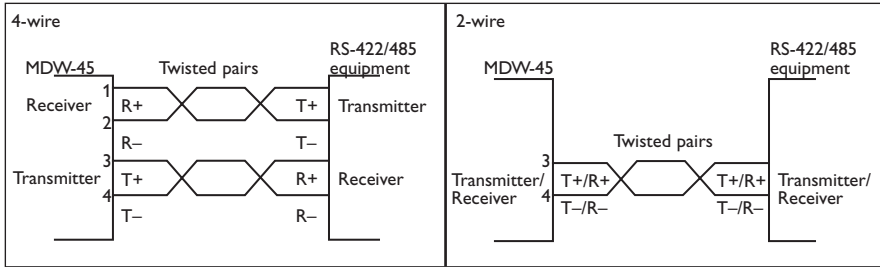

Care recommendations

Follow the care recommendations below to maintain full operation of unit and to fulfil the warranty obligations.

- ⚡ This unit must not be operating with removed covers or lids.
- ⚡ Do not attempt to disassemble the unit.
- ⚡ There are no user serviceable parts inside.
- ⚡ Do not drop, knock or shake the unit, rough handling above the specification may cause damage to internal circuit boards.
- ⚡ Do not use harsh chemicals, cleaning solvents or strong detergents to clean the unit.
- ⚡ Do not paint the unit. Paint can clog the unit and prevent proper operation.
- ⚡ Do not expose the unit to any kind of liquids (rain, beverages, etc).
The unit is not waterproof. Keep the unit within the specified humidity levels.
- ⚡ Do not use or store the unit in dusty, dirty areas, connectors as well as other mechanical part may be damaged.

If the unit is not working properly, contact the place of purchase, nearest Westermo distributor office or Westermo Tech support.



Westermo • SE-640 40 Stora Sundby, Sweden
Tel +46 16 42 80 00 Fax +46 16 42 80 01
E-mail: info@westermo.com
www.westermo.com

Sales Units

Westermo Data Communications

China

sales.cn@westermo.com
www.cn.westermo.com

France

infos@westermo.fr
www.westermo.fr

Germany

info@westermo.de
www.westermo.de

North America

info@westermo.com
www.westermo.com

Singapore

sales@westermo.com.sg
www.westermo.com

Sweden

info.sverige@westermo.se
www.westermo.se

United Kingdom

sales@westermo.co.uk
www.westermo.co.uk

Other Offices



For complete contact information, please visit our website at www.westermo.com/contact or scan the QR code