

User Guide  
6642-22402

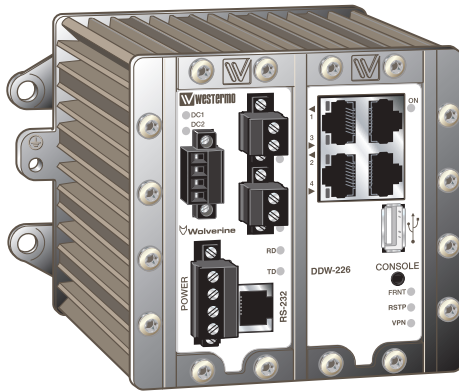

# DDW-226

WOLVERINE SERIES



 **Wolverine**  
Industrial Ethernet  
SHDSL extender

[www.westermo.com](http://www.westermo.com)



## Software tools

Related software tools are available in the folder software tools under technical support on the Westermo website.

## Legal information

The contents of this document are provided "as is". Except as required by applicable law, no warranties of any kind, either express or implied, including, but not limited to, the implied warranties of merchantability and fitness for a particular purpose, are made in relation to the accuracy and reliability or contents of this document. Westermo reserves the right to revise this document or withdraw it at any time without prior notice.

Under no circumstances shall Westermo be responsible for any loss of data or income or any special, incidental, and consequential or indirect damages howsoever caused.

More information about Westermo can be found at the following Internet address:

**<http://www.westermo.com>**

## Safety



### **Before installation:**

Read this manual completely and gather all information on the unit. Make sure that you understand it fully. Check that your application does not exceed the safe operating specifications for this unit.

This unit should only be installed by qualified personnel.

This unit should be built-in to an apparatus cabinet, or similar, where access is restricted to service personnel only.

The power supply wiring must be sufficiently fused, and if necessary it must be possible to disconnect manually from the power supply. Ensure compliance to national installation regulations.

This unit uses convection cooling. To avoid obstructing the airflow around the unit, follow the spacing recommendations (see Cooling section).



### **Before mounting, using or removing this unit:**

Prevent access to hazardous voltage by disconnecting the unit from power supply.

**Warning!** Do not open connected unit. Hazardous voltage may occur within this unit when connected to power supply.

### **Care recommendations**

Follow the care recommendations below to maintain full operation of unit and to fulfil the warranty obligations.

This unit must not be operating with removed covers or lids.

Do not attempt to disassemble the unit. There are no user serviceable parts inside.

Do not drop, knock or shake the unit, rough handling above the specification may cause damage to internal circuit boards.

Do not use harsh chemicals, cleaning solvents or strong detergents to clean the unit.

Do not paint the unit. Paint can clog the unit and prevent proper operation.

Do not expose the unit to any kind of liquids (rain, beverages, etc). The unit is not waterproof. Keep the unit within the specified humidity levels.

Do not use or store the unit in dusty, dirty areas, connectors as well as other mechanical part may be damaged.

If the unit is not working properly, contact the place of purchase, nearest Westermo distributor office or Westermo Tech support.

A readily accessible disconnect device shall be incorporated external to the equipment.

This unit may have hot surfaces when used in high ambient temperature.

### **WARNING:**

When this unit is operated at an ambient temperature above +60°C, the External Surface of Equipment may exceed Touch Temperature Limit according to EN/IEC/UL 60950-1.

### **Maintenance**

No maintenance is required, as long as the unit is used as intended within the specified conditions.

## Agency approvals and standards compliance

Type	Approval / Compliance
EMC	EN 61000-6-1, Immunity residential environments
	EN 61000-6-2, Immunity industrial environments
	EN 61000-6-3, Emission residential environments
	EN 61000-6-4, Emission industrial environments
	EN 50121-4, Railway signalling and telecommunications apparatus
Safety	UL/IEC/EN 60950-1, IT equipment
SHDSL	ITU-T G.991.2

### FCC Part 15.105 Notice:

This equipment has been tested and found to comply with the limits for a Class A digital device, pursuant to Part 15 of the FCC Rules. These limits are designed to provide reasonable protection against harmful interference when the equipment is operated in a commercial environment. This equipment generates, uses, and can radiate radio frequency energy and, if not installed and used in accordance with the instruction manual, may cause harmful interference to radio communications. Operation of this equipment in a residential area is likely to cause harmful interference in which case the user will be required to correct the interference at his own expense.

### Warning

This is a class A product. In a domestic environment this product may cause radio interference in which case the user may be required to take adequate measures.

# Declaration of Conformity



Westermo Teleindustri AB

## Declaration of Conformity

The manufacturer Westermo Teleindustri AB  
SE-640 40 Stora Sundby, Sweden

Herewith declares that the product(s)

Type of product	Models	Art no
Industrial Ethernet SHDSL extender	Wolverine DDW-225	3642-0250
	Wolverine DDW-225 EX	3642-5250
	Wolverine DDW-226	3642-0240
	Wolverine DDW-226 EX	3642-5240

is in conformity with the following EU directive(s).

No	Short name
2014/30/EU	Electromagnetic Compatibility (EMC)
2014/35/EU	Low Voltage Directive (LVD)
2014/34/EU <sup>1</sup>	Equipment Explosive Atmospheres (ATEX)
2011/65/EU	Restriction of the use of certain hazardous substances in electrical and electronic equipment (RoHS)

References of standards applied for this EU declaration of conformity.

No	Title	Issue
EN 61000-6-1	Electromagnetic compatibility – Immunity for residential environments	2007
EN 61000-6-2	Electromagnetic compatibility – Immunity for industrial environments	2005
EN 61000-6-3	Electromagnetic compatibility – Emission residential environments	2007
EN 61000-6-4	Electromagnetic compatibility – Emission for industrial environments	2007
EN 50121-4	Railway applications – Electromagnetic compatibility – Emission and immunity of the signalling and telecommunications apparatus	2015
EN 60950-1	Information technology equipment -- Safety -- General requirements	2006 +A11: 2009
EN 60079-0 <sup>1</sup>	Explosive atmospheres Equipment – General requirements	2012
EN 60079-15 <sup>1</sup>	Electrical apparatus for explosive gas atmospheres –Construction, test and marking of type of protection “n” electrical apparatus	2010
EN 50581	Technical documentation for the assessment of electrical and electronic products with respect to the restriction of hazardous substances	2012

The last two digits of the year in which the CE marking was affixed:

16

  
Signature

Pierre Öberg  
Technical Manager  
21<sup>st</sup> March 2016

<sup>1</sup> Only applicable for article no. 3642-5240, 3642-5250

---

Postadress/Postal address	Tel	Telefax	Postgiro	Bankgiro	Org.nr/ Corp. Identity number	Registered office
S-640 40 Stora Sundby Sweden	016-428000	016-428001	52 72 79-4	5671-5550	556361-2604	Eskilstuna
	Int+46 16428000	Int+46 16428001				

## Ratings

<b>Power</b>	(20 – 48) VDC; 330 mA
<b>Ambient temperature</b>	$-40^{\circ}\text{C} \leq T_a \leq +70^{\circ}\text{C}$
<b>Ingress protection (IP)</b>	IP40
<b>Maximum surface temperature</b>	135°C (temperatur class T4)

## Safety Control Drawing

<b>Degree of protection</b>	IP40
<b>Ambient temperature</b>	$-40^{\circ}\text{C}$ to $+70^{\circ}\text{C}$
<b>Installation spacing</b>	Minimum 25 mm above / below Minimum 10 mm left / right

Direction relative this unit!

Position	Direction*/ descripton	Input/Output values
1	In/Out / SHDSL	$U = \pm 15 \text{ Vpk}$ $I = \pm 25 \text{ mA}$ Data rate up to 15,3 Mbit/s
2	In/Out / SHDSL	

\* Galvanically isolated via signal transformer and capacitively isolated to signal ground through a 1,5 kV 220 pF capacitor.  
See user manual for proven transient protection.

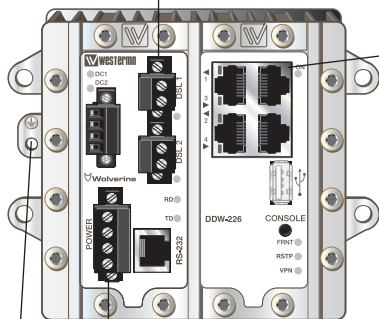

M5 threaded hole for PE connection.

Position	Direction*/ descripton	Input/Output values
1	In/Out / TD+	$U = \pm 1 \text{ V} (4\mu\text{V/s})$ $I = \pm 20 \text{ mA}$ Data rate: 10/100 Mbit/s
2	In/Out / TD-	
3	In/Out / RD+	
4	Not connected	
5	Not connected	
6	In/Out / RD-	
7	Not connected	
8	Not connected	
Shield	PE	

\* Galvanically isolated via signal transformers and capacitively isolated to GND/PE through a 2kV 1000pF capacitor.  
See user manual for proven transient protection.

Position	Direction*/ descripton	Input values	
1	In / +Voltage A	$U_{in} = (16 - 60) \text{ VDC}$ $I_{in} = 420 \text{ mA @ } 16 \text{ VDC}$ $P_{in} = \text{Max } 7 \text{ W}$	
2	In / +Voltage B		
3	In / Common		
4	In / Common		

\* See section *Type tests and environmental conditions* in this user manual for proven transient protection.

Position	Direction*/description	Input/Output values
1	IO / Status +	$U_{in} = 60 \text{ VDC max}$ $U_{in} = 80 \text{ mA max}$
2	IO / Status -	
3	IO / Digital in +	$U_{in} = 60 \text{ VDC max}$ $U_{in} = 10 \text{ mA max}$
4	IO / Digital in -	

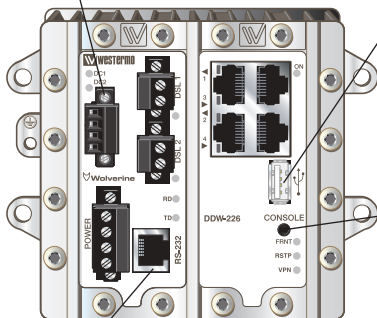
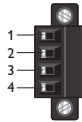

Position	Direction/description	Input values
1	Out / VBUS	$U_{out} = 5 \text{ VDC max}$ $I_{out} = 500 \text{ mA max}$
2	In/out / D-	
3	In/out / D+	
4	GND	
Shield	PE	

Position	Direction/description	Input/Output values
1	In/out / GND	$U = 3.3 \text{ VDC max}$ $I = 24 \text{ mA max}$
2	Out / Tx	
3	In / Rx	

Position	Description	Input/Output values
1	Out / Data Set Ready (DSR)	$U_{max} = \pm 12 \text{ Vpk}$ $I_{max} = \pm 60 \text{ mA}$ Data rate: 0.3 – 115.2 kbit/s
2	Out / Data Carrier Detect (DCD)	
3	In / Data Terminal Ready (DTR)	
4	In/Out / Signal Ground (SG)	
5	Out / Receive Data (RD)	
6	In / Transmit Data (TD)	
7	Out / Clear To Send (CTS)	
8	In / Request To Send (RTS)	
Shield	In/Out / Connected to PE	

## Type tests and environmental conditions

Phenomena	Test	Description	Test levels
ESD	EN 61000-4-2	Enclosure contact	± 6 kV
		Enclosure air	± 8 kV
RF field AM modulated	IEC 61000-4-3	Enclosure	20 V/m 80% AM (1 kHz), 80 – 2700 MHz 10 V/m 80% AM (1 kHz), 2700 – 6000 MHz
Fast transient	EN 61000-4-4	Signal ports	± 2 kV
		Power ports	± 2 kV
Surge	EN 61000-4-5	Signal ports unbalanced	± 2 kV line to earth, ± 2 kV line to line
		Signal ports balanced	± 2 kV line to earth, ± 1 kV line to line
		Power ports	± 2 kV line to earth, ± 1 kV line to line
RF conducted	EN 61000-4-6	Signal ports	10 V 80% AM (1 kHz), 0.15 – 80 MHz
		Power ports	10 V 80% AM (1 kHz), 0.15 – 80 MHz
Power frequency magnetic field	EN 61000-4-8	Enclosure	300 A/m
Pulse magnetic field	EN 61000-4-9	Enclosure	300 A/m
Mains freq. 50 Hz	EN 61000-4-16	Signal ports	100 V 50 Hz line to earth
Mains freq. 50 Hz	SS 436 15 03	Signal ports	250 V 50 Hz line to line
Voltage dips and interruption	EN 61000-4-29	DC power ports	10 ms, interruption 10 ms, 30% reduction 10 ms, 60% reduction +20% above & -20% below rated voltage
Radiated emission	CISPR 16-2-3 ANSI C63.4 (FCC part 15)	Enclosure	Class A, 30 – 6000 MHz
		Enclosure	Class A, 30 – 6500 MHz
Conducted emission	CISPR 16-2-1	DC power ports	Class A
Dielectric strength	EN 60950	Signal port to other isolated ports	1500 Vrms 50 Hz 1 min
		Power port to other isolated ports	1500 Vrms 50 Hz 1 min
Temperature	EN 60068-2-1	Operating	-40 to +70°C
	EN 60068-2-2	Storage & Transport	-40 to +85°C
		Maximum surface temperature	135°C (temperature class T4)
Humidity	EN 60068-2-30	Operating	5 to 95% relative humidity
		Storage & Transport	5 to 95% relative humidity
Altitude		Operating	2 000 m / 70 kPa
Reliability prediction (MTBF)	MIL-HDBK-217F	Operating	370 000 hours @ 25°C
Service life		Operating	10 year
Vibration	IEC 60068-2-6	Operating	7.5 mm, 5 – 8 Hz 2 g, 8 – 500 Hz
Shock	IEC 60068-2-27	Operating	15 g, 11 ms
Enclosure	UL 94	Aluminium/Zink	Flammability class V-0
Dimension W x H x D			134 x 105 x 122 mm
Weight			1.5 kg
Degree of protection	IEC 60529	Enclosure	IP40



## Description

DDW-226 is an Ethernet extender with integrated switch and support for legacy serial connections. It uses the Westermo WeOS operating system that provides the DDW-226 with all the advanced switching and routing functionality supported by the DDW-226. These functions include VLAN support, Layer 2/3 switching, Static Routing, Firewall functions, IGMP Snooping, VPN support.

A further enhancement the DDW-226 provides is a set of advanced diagnostic functions that allow the SHDSL line to be dynamically monitored allowing alarms to be configured to pre-warn of any performance issues. This monitoring data can be accessed in a number of ways; it can be read at any time through the Web Interface, Command Line Interface or via SNMP.

A key function of the DDW-226 is its ability to be used to create redundant ring networks over the SHDSL links, using both the Westermo FRNT protocol, but also RSTP.

- ⌘ Serial port
- ⌘ Up to 15.3 Mbit/s over old cables
- ⌘ Redundant ring on the SHDSL interface
- ⌘ Advanced Diagnostics
- ⌘ VLAN support and IGMP Snooping
- ⌘ VPN support

## Interface specifications

<b>Power</b>	
Rated voltage	20 to 48 VDC
Operating voltage	16 to 60 VDC
Rated current	330 mA (495 mA) @ 20 VDC (with 500 mA USB load) 150 mA (215 mA) @ 48 VDC (with 500 mA USB load)
Rated frequency	DC
Inrush current, I <sup>2</sup> t	1.5 A <sup>2</sup> s
Startup current*	400 mA
Polarity	Reverse polarity protected
Redundant power input	Yes
Isolation to	All other
Connection	Detachable screw terminal
Connector size	0.2 – 2.5 mm <sup>2</sup> (AWG 24 – 12)
Shielded cable	Not required

\* External supply current capability for proper startup.

<b>Console</b>	
Electrical specification	TTL-level
Data rate	115.2 kbit/s
Data format	8 data bits, none parity, 1 stop bit, no flow control
Circuit type	SELV
Isolation to	All other except USB
Galvanic connection to	USB
Connection	2.5 mm jack, use Westermo cable 1211-2027

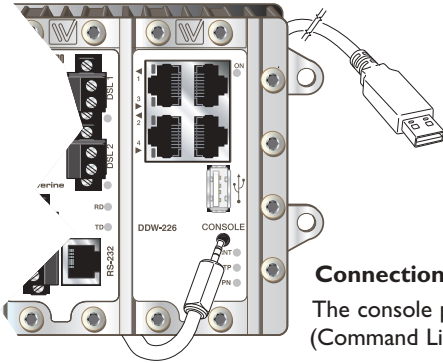

### Connection to console port

The console port can be used to connect to the CLI (Command Line Interface).

#### The following steps needs to be taken

1. Connect the serial diagnostic cable to the console port (use only Westermo cable 1211-2027).
2. Connect cable to your computer (USB port, if drivers are needed they can be downloaded from our Web page).
3. Use a terminal emulator and connect with correct speed and format to the assigned port.

For more information about the CLI, see the WeOS management guide.

USB	
Electrical specification	USB 2.0 host interface
Data rate	Up to 12 Mbit/s (full-speed mode)
Circuit type	SELV
Maximum supply current	500 mA
Isolation to	All other except Console
Galvanic connection to	Console
Connection	USB receptacle connector type A
Conductive housing	Yes

I/O / Relay output	
Connect resistance	30 $\Omega$
Isolation to	All other
Connection	Detachable screw terminal
Connector size	0.2 – 2.5 mm <sup>2</sup> (AWG 24 – 12)
Maximum voltage/current	60 VDC / 80 mA
I/O / Digital input	
Voltage levels	Logic one >12V, Logic zero <1V
Isolation to	All other
Connection	Detachable screw terminal
Connector size	0.2 – 2.5 mm <sup>2</sup> (AWG 24 – 12)

<b>Ethernet TX</b>	
Electrical specification	IEEE std 802.3. 2005 Edition
Data rate	10 Mbit/s or 100 Mbit/s, manual or auto
Duplex	Full or half, manual or auto
Circuit type	TNV-1
Transmission range	Up to 150 m with CAT5e cable or better
Isolation to	All other
Connection	RJ-45 auto MDI/MDI-X
Shielded cable	Not required, except when installed in Railway applications as signalling and telecommunications apparatus and located close to rails.*
Conductive housing	Yes
Number of ports	4

\* To minimise the risk of interference, a shielded cable is recommended when the cable is located inside 3 m boundary or the cable is longer than 30 m and inside 10 m boundary to the rails and connected to this port.

<b>SHDSL</b>	
Electrical specification	ITU-T G.991.2 Annex B
Data rate	32 kbit/s to 15.3 Mbit/s
Protocol	EFM according to IEEE 802.3-2005
Transmission range	According to ITU-T G.991.2 depending on line quality
Isolation to	All other
Connection	Detachable screw terminal
Connector size	0.2 – 2.5 mm <sup>2</sup> (AWG 24 – 12)
Shielded cable	Not required
Number of ports	2

<b>RS-232</b>	
Electrical specification	EIA RS-232
Data rate	300 bit/s – 115.2 kbit/s
Data format	7 or 8 data bits, odd/even/none parity, 1 or 2 stop bits
Protocol	Transparent, optimised by packing algorithm
Circuit type	SELV
Transmission range	15 m / 49 ft
Isolation to	Power, DSL, Ethernet
Galvanic connection to	USB, Console
Connection	RJ-45
Shielded cable	Not required
Conductive housing	Yes

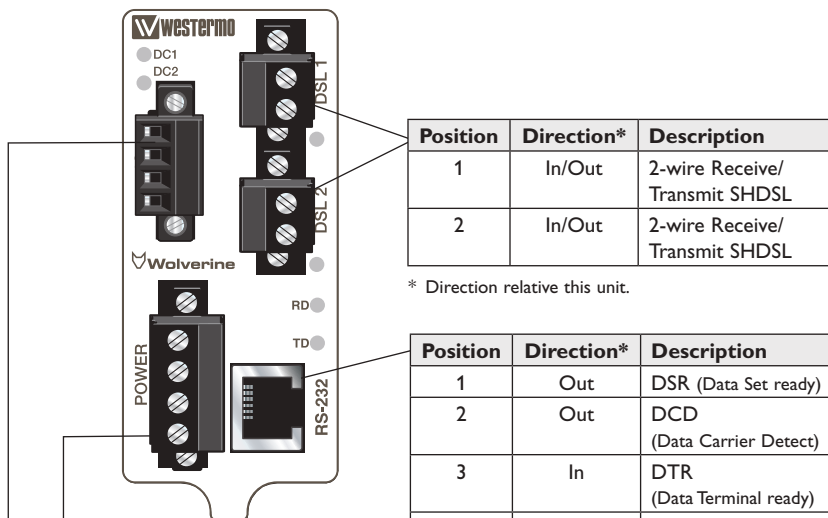

Position	Direction*	Description
1	In/Out	2-wire Receive/ Transmit SHDSL
2	In/Out	2-wire Receive/ Transmit SHDSL

\* Direction relative this unit.

Position	Direction*	Description
1	Out	DSR (Data Set ready)
2	Out	DCD (Data Carrier Detect)
3	In	DTR (Data Terminal ready)
4	In/Out	SG (Signal Ground)
5	Out	RD (Receive Data)
6	In	TD (Transmit Data)
7	Out	CTS (Clear To Send)
8	In	RTS (Request To Send)
Shield	In/Out	Connected to PE

\* Direction relative this unit.

Position	Direction*	Description	Product marking
1	In	+ Voltage A	+DC1
2	In	+ Voltage B	+DC2
3	In	Common	COM
4	In	Common	COM

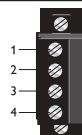

\* Direction relative this unit.

Position	Direction*	Description
1	Out	Status +
2	Out	Status -
3	In	Digital in +
4	In	Digital in -

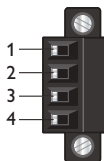

\* Direction relative this unit.

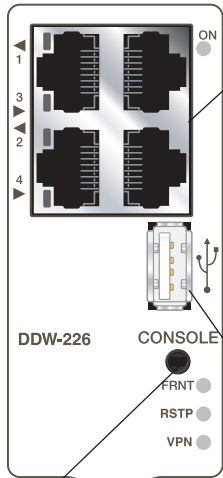

Console  
(see more information  
on page 10 and 11)

Position	Direction*	Description
1	In/Out	TD+
2	In/Out	TD-
3	In/Out	RD+
4	-	Not connected
5	-	Not connected
6	In/Out	RD-
7	-	Not connected
8	-	Not connected
Shield	In/Out	Connected to PE

\* Direction relative this unit.

Position	Direction*	Description
1	Out	VBUS
2	In/Out	D-
3	In/Out	D+
4	Out	GND
Shield	In/Out	Connected to PE

\* Direction relative this unit.

# LED indicators

LED	Status	Description
ON	OFF	Unit has no power.
	GREEN	All OK, no alarm condition.
	RED	Alarm condition, or until unit has started up. (Alarm conditions are configurable, see "WeOS Management Guide").
	BLINK	Location indicator ("Here I am!"). Activated when connected to IPConfig Tool, or upon request from Web or CLI.
DC1	OFF	Unit has no power.
	GREEN	Power OK on DC1.
	RED	Power failure on +DC1.
DC2	OFF	Unit has no power.
	GREEN	Power OK on DC2.
	RED	Power failure on +DC2.
FRNT	OFF	FRNT disabled.
	GREEN	FRNT OK.
	RED	FRNT Error.
	BLINK	Unit configured as FRNT Focal Point.
RSTP	OFF	RSTP disabled.
	GREEN	RSTP enabled.
	BLINK	Unit elected as RSTP/STP root switch.
VPN	OFF	VPN disabled.
	GREEN	(Configurable) Default: At least one VPN tunnel up and OK.
	RED	(Configurable) Default: All VPN tunnels down.
Copper ports Port 1-4	OFF	No Link.
	GREEN	Link established.
	GREEN FLASH	Data traffic indication.
	YELLOW	Port alarm and no link. Or if FRNT or RSTP mode, port is blocked.
DSL ports Port 1-2	OFF	No SHDSL link.
	GREEN	SHDSL link established.
	GREEN BLINK	SHDSL link negotiation.
	GREEN FLASH	Data traffic indication.
	YELLOW	Port alarm and no link. Or if FRNT or RSTP mode, port is blocked.
	YELLOW BLINK	Only during unit startup. Firmware downloading to SHDSL chip.
<b>Serial port, RS-232 (DCE mode)</b>		
TD	OFF	No serial data received
	GREEN FLASH	Serial data received
RD	OFF	No serial data transmitted
	GREEN FLASH	Serial data transmitted

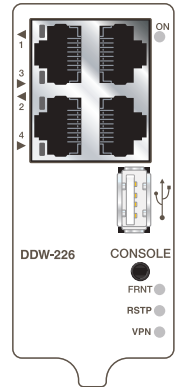
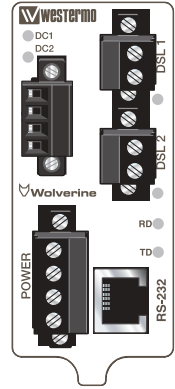

## Mounting

### Mounting, 35 mm DIN-rail

The unit can be mounted on a 35 mm DIN-rail, which is horizontally mounted inside an apparatus cabinet, or similar. Snap on mounting, see figure.

**Note!** For proper vibration and chock performance Westermo recommends standard top-hat DIN-rail TH 35-15 according to EN 60715.

### Removal

Press down the support at the back of the unit using a screwdriver. See figure.

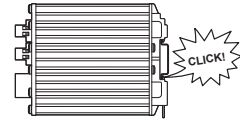
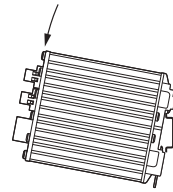
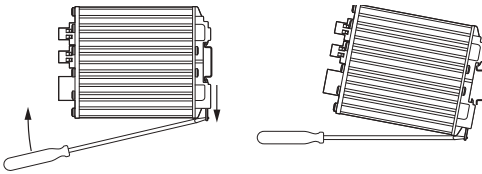

### Wall mounting

This unit can also be wall-mounted, see figure.

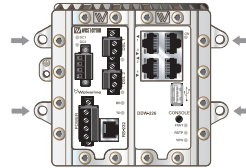

### Earth connection

For correct function the ground connection on the unit needs to be properly connected to a solid ground. See figure.

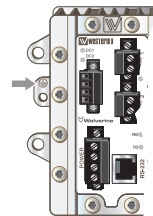

### Cooling

This unit uses convection cooling. To avoid obstructing the airflow around the unit, use the following spacing rules. Minimum spacing 25 mm (1.0 inch) above/below and 10 mm (0.4 inches) left/right the unit.

Spacing is recommended for the use of unit in full operating temperature range and service life. See figure.

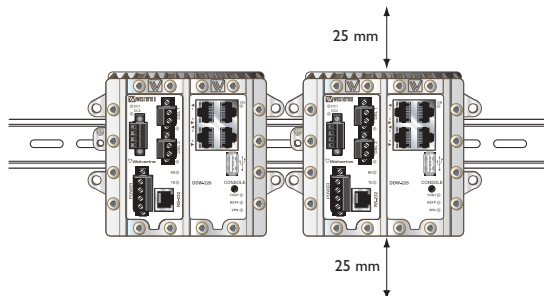



## Getting Started

This product runs Westermo Operating System (WeOS) which provides several management tools that can be used for configuration of the unit.

- **IPConfig tool**  
This is a custom Westermo tool used for discovery of attached Westermo units.
- **Web**  
Configuration of the unit using the web browser.
- **CLI**  
Configuration of the unit via the Command Line Interface.

If the computer is located in the same subnet as the switch you can easily use a web browser to configure the unit. Within the web you can configure most of the available functions.

For advanced network settings and more diagnostic information, please use the CLI. Detailed documentation is available in the chapter "The Command Line Management Tool" in the WeOS management guide.

Factory default	<i>IP address:</i>	192.168.2.200
	<i>Netmask:</i>	255.255.255.0
	<i>Gateway:</i>	Disabled

**Note!** If you are not sure about the subnet – consult your network administrator.

## Configuration

### Configure the unit via web browser

The unit can easily be configured via a Web browser.

Open the link <http://192.168.2.200> in your web browser, and you will be prompted with a Login screen, where the default settings for Username and Password are:

*Username:* admin

*Password:* westermo

Once you have logged in, you can use the extensive integrated help function describing all configuration options. Two common task when configuring a new switch is to assign appropriate IP settings, and to change the password of the admin account.

The password can be up to 64 characters long, and should consist of printable ASCII characters (ASCII 33-126); 'Space' is not a valid password character.

**Note!** Version of IP Config tool must be 10.3.0 or higher.

## Referring documents

Type	Description	Document number
Management Guide	Westermo OS management guide	6101-3201

## Factory default on DDW-226

It is possible to set the unit to factory default settings by using two standard Ethernet RJ-45 cables.

1. Power off the switch and disconnect all Ethernet cables and DSL cables.
  2. Connect one Ethernet cable between Ethernet port 1 and Ethernet port 4, and another Ethernet cable between Ethernet port 2 and Ethernet port 3.  
The ports need to be connected directly by Ethernet cables, i.e., not via a hub or switch. Use straight cables – not cross-over cables – when connecting the port pairs.
  3. Power on the unit.
  4. Wait for the unit to start up. Control that the ON LED is flashing red.  
The ON LED flashing indicates that the unit is now ready to be reset to factory default. You now have the choice to go ahead with the factory reset, or to skip factory reset and boot as normal.
    - Go ahead with factory reset:  
Acknowledge that you wish to conduct the factory reset by unplugging one of the Ethernet cables. The ON LED will stop flashing.  
This initiates the factory reset process\*, and after approximately 1 minute the unit will restart with factory default settings. When the switch has booted up, the ON LED will typically show a green light (a red light is shown if only one of the DC power feeds is connected).
    - Skip the factory reset:  
To skip the factory reset process, just wait for approximately 30 seconds (after the ON LED starts flashing RED) without unplugging any of the Ethernet cables. The switch will conduct a normal boot with the existing settings.
- \* **Note** Do not power off the unit while the factory reset process is in progress.





Westermo • SE-640 40 Stora Sundby, Sweden  
Tel +46 16 42 80 00 Fax +46 16 42 80 01  
E-mail: [info@westermo.com](mailto:info@westermo.com)  
[www.westermo.com](http://www.westermo.com)

## Sales Units

### Westermo Data Communications

---

#### China

[sales.cn@westermo.com](mailto:sales.cn@westermo.com)  
[www.cn.westermo.com](http://www.cn.westermo.com)

#### France

[infos@westermo.fr](mailto:infos@westermo.fr)  
[www.westermo.fr](http://www.westermo.fr)

#### Germany

[info@westermo.de](mailto:info@westermo.de)  
[www.westermo.de](http://www.westermo.de)

#### North America

[info@westermo.com](mailto:info@westermo.com)  
[www.westermo.com](http://www.westermo.com)

#### Singapore

[sales@westermo.com.sg](mailto:sales@westermo.com.sg)  
[www.westermo.com](http://www.westermo.com)

#### Sweden

[info.sverige@westermo.se](mailto:info.sverige@westermo.se)  
[www.westermo.se](http://www.westermo.se)

#### United Kingdom

[sales@westermo.co.uk](mailto:sales@westermo.co.uk)  
[www.westermo.co.uk](http://www.westermo.co.uk)

#### Other Offices



*For complete contact information, please visit our website at [www.westermo.com/contact](http://www.westermo.com/contact) or scan the QR code*