

# ioLogik R2140 User's Manual

---

Edition 7.1, January 2017

[www.moxa.com/product](http://www.moxa.com/product)



© 2017 Moxa Inc. All rights reserved.

# ioLogik R2140 User's Manual

The software described in this manual is furnished under a license agreement and may be used only in accordance with the terms of that agreement.

## Copyright Notice

© 2017 Moxa Inc. All rights reserved.

## Trademarks

The MOXA logo is a registered trademark of Moxa Inc.  
All other trademarks or registered marks in this manual belong to their respective manufacturers.

## Disclaimer

Information in this document is subject to change without notice and does not represent a commitment on the part of Moxa.

Moxa provides this document as is, without warranty of any kind, either expressed or implied, including, but not limited to, its particular purpose. Moxa reserves the right to make improvements and/or changes to this manual, or to the products and/or the programs described in this manual, at any time.

Information provided in this manual is intended to be accurate and reliable. However, Moxa assumes no responsibility for its use, or for any infringements on the rights of third parties that may result from its use.

This product might include unintentional technical or typographical errors. Changes are periodically made to the information herein to correct such errors, and these changes are incorporated into new editions of the publication.

## Technical Support Contact Information

[www.moxa.com/support](http://www.moxa.com/support)

### **Moxa Americas**

Toll-free: 1-888-669-2872  
Tel: +1-714-528-6777  
Fax: +1-714-528-6778

### **Moxa Europe**

Tel: +49-89-3 70 03 99-0  
Fax: +49-89-3 70 03 99-99

### **Moxa India**

Tel: +91-80-4172-9088  
Fax: +91-80-4132-1045

### **Moxa China (Shanghai office)**

Toll-free: 800-820-5036  
Tel: +86-21-5258-9955  
Fax: +86-21-5258-5505

### **Moxa Asia-Pacific**

Tel: +886-2-8919-1230  
Fax: +886-2-8919-1231

# Table of Contents

<b>1. Introduction</b>	<b>1-1</b>
Overview	1-2
Optional Liquid Crystal Display Module (LCM)	1-2
Product Features	1-2
Package Checklist	1-2
Specifications	1-3
Physical Dimensions	1-4
Without LCM	1-4
With Optional LCM	1-5
Product Overview	1-6
Pin Assignments	1-6
System Bus	1-6
TB1 and TB2 (Power Input & RS-485 Connector)	1-6
TB3 (Analog Input and Output Terminal)	1-7
LED Indicators	1-7
<b>2. Initial Setup</b>	<b>2-1</b>
Hardware Installation	2-2
Connecting the Power	2-2
Grounding the ioLogik R2140	2-2
Connecting to Analog Sensors and Devices	2-2
Setting the RS-485 Baudrate	2-3
Setting the RS-485 Unit ID	2-3
Modbus/RTU Devices	2-3
Software Installation	2-4
<b>3. Using ioAdmin</b>	<b>3-1</b>
Introduction to ioAdmin	3-2
Features of ioAdmin	3-2
Searching for the Unit	3-3
ioAdmin Main Screen	3-5
Main Screen Overview	3-5
Wiring Guide	3-6
Menu Items	3-7
File	3-7
System	3-7
Sort	3-8
Help	3-8
Quick Links	3-8
Main Window	3-9
I/O Configuration Tab (General)	3-9
Server Info Tab	3-9
Server Settings Tab (General)	3-10
ioAdmin Administrator Functions	3-10
I/O Configuration Tab (Administrator)	3-11
Server Settings Tab (Administrator)	3-12
Firmware Update Tab	3-12
Watchdog Tab	3-13
Server Context Menu	3-14
<b>4. Cascading with Other I/O Servers</b>	<b>4-1</b>
Introduction	4-2
Cascading System Bus	4-2
Hardware Installation	4-2
Using ioAdmin with Cascaded I/O Servers	4-3
Adding One I/O Server	4-3
Adding Two or More I/O Servers	4-4
Removing Cascaded I/O Servers	4-5
Limitations	4-5
<b>A. Liquid Crystal Display Module (LCM)</b>	<b>A-1</b>
<b>B. Modbus/RTU Address Mappings</b>	<b>B-1</b>
R2140 Modbus Mapping	B-1
0xxxx Read/Write Coils (Functions 1, 5, 15)	B-1
3xxxx Read Only Registers (Function 4)	B-3
4xxxx Read/Write Registers (Functions 3, 6, 16)	B-4
Function 8	B-8
<b>C. Factory Default Settings</b>	<b>C-1</b>
<b>D. Pinouts and Cable Wiring</b>	<b>D-1</b>

Pin Assignments .....	D-1
System Bus .....	D-1
TB1 and TB2 (Power Input & RS-485 Connector) .....	D-1
TB3 (Analog Input and Output Terminal) .....	D-2
Analog Output .....	D-2
Schematic .....	D-2
Connection .....	D-2
Analog Input .....	D-3
Voltage Mode Schematic .....	D-3
Current Mode Schematic .....	D-3
Connection .....	D-3

# Introduction

---

The ioLogik R2140 is a stand-alone remote analog I/O server that can connect sensors for automation applications over an RS-485 connection.

The following topics are covered in this chapter:

- **Overview**
- **Optional Liquid Crystal Display Module (LCM)**
- **Product Features**
- **Package Checklist**
- **Specifications**
- **Physical Dimensions**
  - Without LCM
  - With Optional LCM
- **Product Overview**
- **Pin Assignments**
  - System Bus
  - TB1 and TB2 (Power Input & RS-485 Connector)
  - TB3 (Analog Input and Output Terminal)
  - LED Indicators

## Overview



The ioLogik R2140 is a remote I/O server that is designed to link sensors, transmitters, transducers, and valves to an RS-485 network.

The ioLogik R2140 can be attached to an ioLogik E2000 server so I/O points can be accessed from within a single IP environment. One ioLogik E2000 server can connect up to 31 ioLogik R2000 servers.

## Optional Liquid Crystal Display Module (LCM)

The ioLogik R2140 supports an optional hot-pluggable liquid crystal display module (LCM) for field management and configuration. The module can be used for on-site configuration or monitoring, and works with any ioLogik E or R series product.

## Product Features

- 8 analog input (AI) channels, mV/V/mA with wire-off detection (at 4 to 20 mA)
- 2 analog output (AO) channels for voltage or current actuator control
- Bundled Windows utility and quick programming library for VB, VC++, BCB
- Support for SCADA software such as Wonderware InTouch and GE Intellution iFix32
- Configurable power-on and safe status settings for AO channels
- Optional LCM for status display and configuration
- NIST traceable calibration
- ROHS compliant

## Package Checklist

The ioLogik R2140 is shipped with the following items:

### Standard Accessories

- ioLogik R2140 RS-485 I/O server

### Optional Accessories

- LDP1602 ioLogik liquid crystal display module (LCM)

**NOTE:** Notify your sales representative if any of the above items are missing or damaged.

# Specifications

## Serial Communication

**Interface:** RS-485-2w: Data+, Data-, GND (3-contact terminal block)

**Serial Line Protection:** 15 kV ESD for all signals

## Serial Communication Parameters

**Parity:** None

**Data Bits:** 8

**Stop Bits:** 1

**Flow Control:** None

**Baudrate:** 9600 to 115200 bps

**Protocol:** Modbus/RTU

## Inputs and Outputs

**Isolation:** 3K VDC or 2K Vrms

**Analog Inputs:** 8 channels

**Analog Outputs:** 2 channels

## Analog Input

**Resolution:** 16 bits

**I/O Mode:** Voltage / Current

**Input Range:**  $\pm 150$  mV,  $\pm 500$  mV,  $\pm 5$  V,  $\pm 10$  V, 0 to 20 mA, 4 to 20 mA

**Accuracy:**

$\pm 0.1\%$  FSR @ 25°C

$\pm 0.3\%$  FSR @ -10 and 60°C

**Sampling Rate:** (for current)

All channels: 6 samples/sec

• Per channel: 0.75 samples/sec

• Only one channel enabled: 0.75 samples/sec

**Built-in Resistor for Current Input:** 106 ohms

**Input Impedance:** 900 k $\Omega$

## Analog Output

**Resolution:** 12 bits

**Output Range:** 0 to 10 V, 4 to 20 mA

**Drive Voltage:** 15 VDC for current output

**Accuracy:**

$\pm 0.1\%$  FSR @ 25°C,

$\pm 0.3\%$  FSR @ -10 and 60°C

**Load Resistor:** Less than 250 ohms

## Power Requirements

**Power Input:** 24 VDC nominal, 12 to 48 VDC

**Power Consumption:** 170 mA @ 24 VDC

## Physical Characteristics

**Wiring:** I/O cable max. 14 AWG

**Dimensions:** 115 x 79 x 45.6 mm (4.53 x 3.11 x 1.80 in)

**Note:** Please see pages 14-26 for this product's dimensions diagram.

**Weight:** 200 g

**Mounting:** DIN rail or wall

## Environmental Limits

**Operating Temperature:** -10 to 60°C (14 to 140°F)

**Storage Temperature:** -40 to 85°C (-40 to 185°F)

**Ambient Relative Humidity:** 5 to 95% (non-condensing)

**Altitude:** Up to 2000 m

**Note:** Please contact Moxa if you require products guaranteed to function properly at higher altitudes.

### Standards and Certifications

**Safety:** UL 508

**EMI:**

EN 61000-3-2; EN 61000-3-3;

EN 61000-6-4; FCC Part 15, Subpart B, Class A

**EMS:**

EN 61000-4-2, EN 61000-4-3, EN 61000-4-4,

EN 61000-4-5, EN 61000-4-6, EN 61000-4-8,

EN 61000-4-11, EN 61000-6-2

**Shock:** IEC 60068-2-27

**Freefall:** IEC 60068-2-32

**Vibration:** IEC 60068-2-6

**Green Product:** RoHS, CRoHS, WEEE

**Note:** Please check Moxa's website for the most up-to-date certification status.

**MTBF** (mean time between failures)

**Time:** 280,923 hrs

**Database:** Telcordia (Bellcore)

### Warranty

**Warranty Period:** 5 years

**Details:** See [www.moxa.com/warranty](http://www.moxa.com/warranty)

## Physical Dimensions

### Without LCM

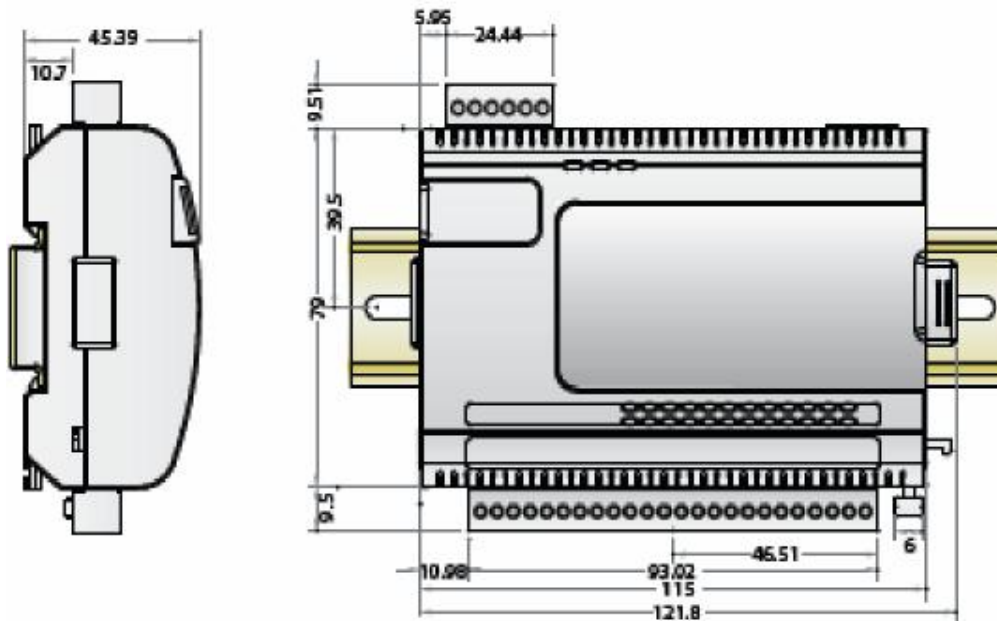

(all units in mm)



### With Optional LCM

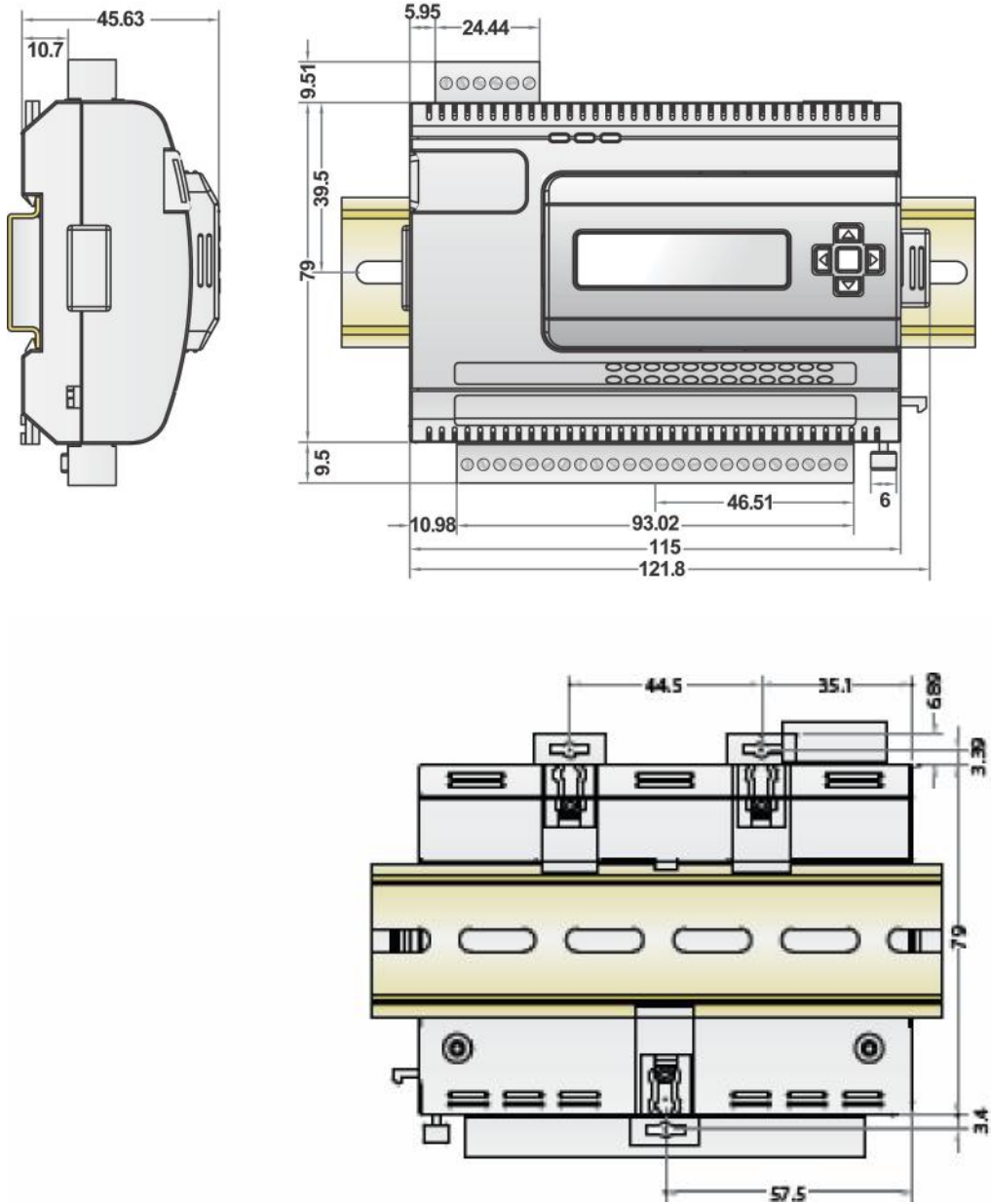

(all units in mm)

# Product Overview

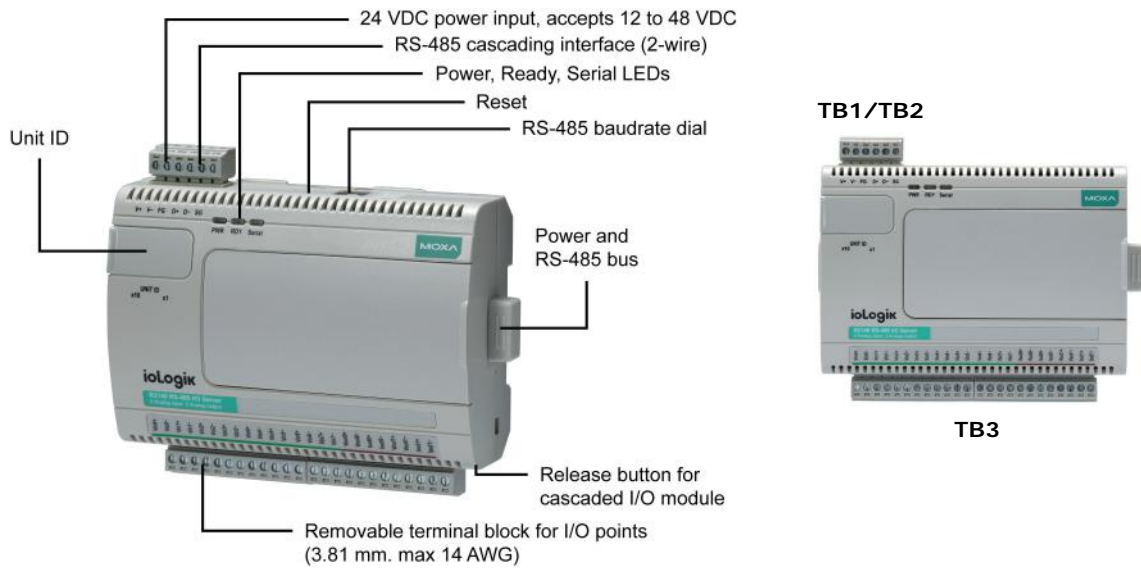

**NOTE** The reset button restarts the server and resets all settings to factory defaults. Use a pointed object such as a straightened paper clip to hold the reset button down for 5 sec. The RDY LED will turn red as you are holding the reset button down. The factory defaults will be loaded once the RDY LED turns green again. You may then release the reset button.

## Pin Assignments

### System Bus

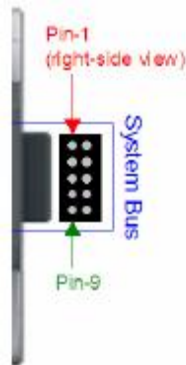

<b>Pin</b>	1	2	3	4	5
<b>Signal</b>	V+	V-	V+	V-	NC

<b>Pin</b>	6	7	8	9	10
<b>Signal</b>	NC	Data+	SYNC	Data-	GND

### TB1 and TB2 (Power Input & RS-485 Connector)

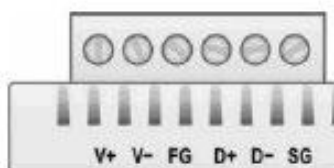

	TB1 (Power Input)			TB2 (RS-485)		
<b>Pin</b>	1	2	3	4	5	6
<b>Signal</b>	V+	V-	FG	D+	D-	SG

NOTE: FG is Frame Ground, SG is Signal Ground

## TB3 (Analog Input and Output Terminal)

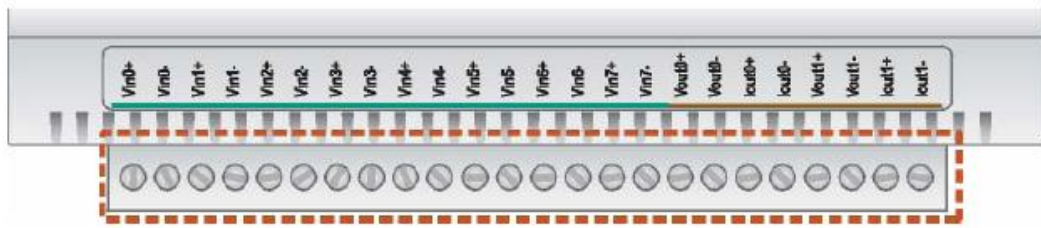

<b>Pin</b>	1	2	3	4	5	6	7	8	9
<b>Signal</b>	VIN0+	VIN0-	VIN1+	VIN1-	VIN2+	VIN2-	VIN3+	VIN3-	VIN4+

<b>Pin</b>	10	11	12	13	14	15	16	17	18
<b>Signal</b>	VIN4-	VIN5+	VIN5-	VIN6+	VIN6-	VIN7+	VIN7-	VOUT0+	VOUT0-

<b>Pin</b>	19	20	21	22	23	24
<b>Signal</b>	IOUT 0+	IOUT 0-	VOUT1+	VOUT1-	IOUT 1+	IOUT 1-

## LED Indicators

System LEDs		
PWR	red	Power is on
	off	Power is off
RDY	red	System error
	green (steady)	ioLogik is functioning normally
	green & red (flashing)	ioLogik is in Safe Status
	off	Power is off or there is a power problem
Serial	(flashing)	Serial port is receiving/transmitting data

# 2

## Initial Setup

---

This chapter describes how to install the ioLogik R2140.

The following topics are covered in this chapter:

### ▣ **Hardware Installation**

- Connecting the Power
- Grounding the ioLogik R2140
- Connecting to Analog Sensors and Devices
- Setting the RS-485 Baudrate
- Setting the RS-485 Unit ID
- Modbus/RTU Devices

### ▣ **Software Installation**

# Hardware Installation

## Connecting the Power

Connect the 12 to 48 VDC power line to the ioLogik R2140's terminal block (TB1). If power is properly supplied, the power LED will glow a solid red color until the system is ready



### ATTENTION

**Disconnect the power before installing and wiring.**

Disconnect the power cord before installing and/or wiring your ioLogik R2140.

**To protect your system, power up the ioLogik first, then the sensors.**

When powering down, shut off power to the sensors first, then the ioLogik.

**Do not exceed the maximum current for the wiring.**

Determine the maximum possible current for each power wire and common wire. Observe all electrical codes dictating the maximum current allowable for each wire size. If the current exceeds the maximum rating, the wiring could overheat, causing serious damage to your equipment.

## Grounding the ioLogik R2140

The ioLogik R2140 is equipped with two grounding points, one on the back wall-mounting plate and the other on the DIN-rail attachment. Both grounding points are connected to the same conducting pathway.

## Connecting to Analog Sensors and Devices

### Analog Output

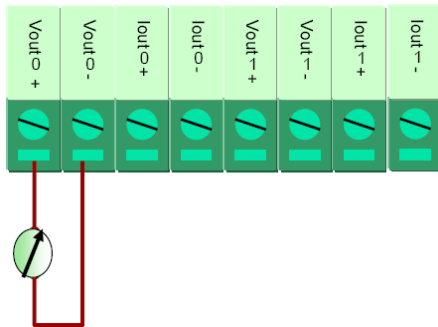

### Analog Input

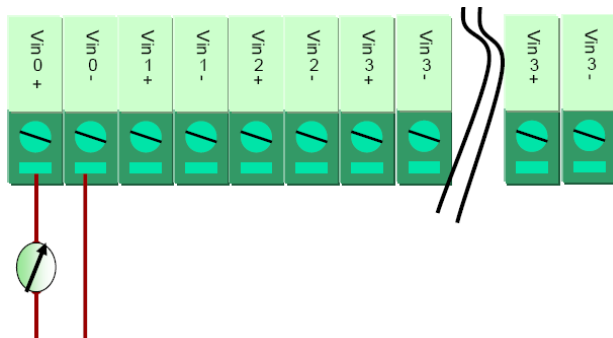

## Setting the RS-485 Baudrate

The RS-485 port is used to communicate with other RS-485 devices or to link to another ioLogik RS-485 I/O server. The RS-485 port can run Modbus/RTU or I/O command sets. The baudrate is set by a physical dial on the back of the ioLogik R2140. The default settings are baudrate = 115200, parity check = N, data bits = 8, and stop bit = 1.

	Baudrate for RS-485 (parameters are N, 8, 1)	Dial setting and corresponding baudrate: 0:115200 1:57600 2:38400 3:19200 4:9600 5:4800 6:2400 7:1200
---	---	---

## Setting the RS-485 Unit ID



The ioLogik R2140 needs to be assigned a unit ID in order to use the RS-485 bus. You may assign a number from 1 to 31. Unit ID 0 is reserved for the first device on the RS-485 bus, such as a PC or PLC.

## Modbus/RTU Devices

The RS-485 port runs Modbus/RTU and can connect to any Modbus device. You may use different methods to connect different combinations of ioLogik R2000 servers and other Modbus devices. Some examples are shown below:

### Connecting One Modbus/RTU Device

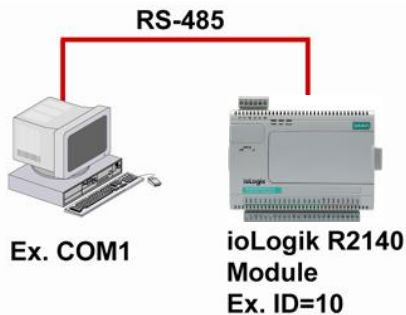

### Connecting Multiple Modbus/RTU Devices

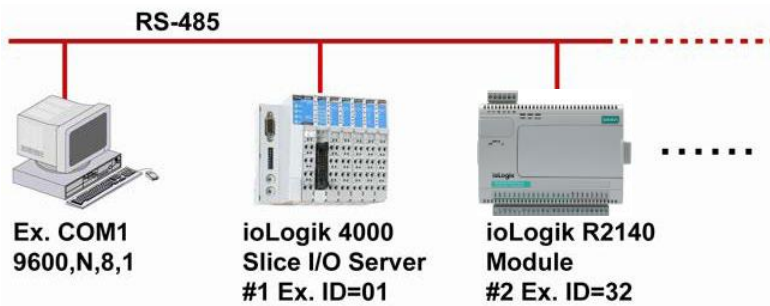

# Software Installation

ioAdmin is a Windows utility that can connect to the ioLogik R2140 for configuration and management. The ioLogik R2140 may also be configured through the optional LCM.

1. **Installing ioAdmin:** Download the ioAdmin utility from Moxa's website, double click the installation file, and then follow the installation wizard's instructions to complete the installation. You can also download and install the MXIO DLL library or ioEventLog separately.
2. **Open ioAdmin:** After installation is finished, run ioAdmin from **Start → Program Files → MOXA → IO Server → Utility → ioAdmin**.
3. **Search for the server:** On the menu bar, select **System → Auto Scan Remote I/O Server**. In the dialog window, select **RS-232/485 I/O server** and click **Start Search**.

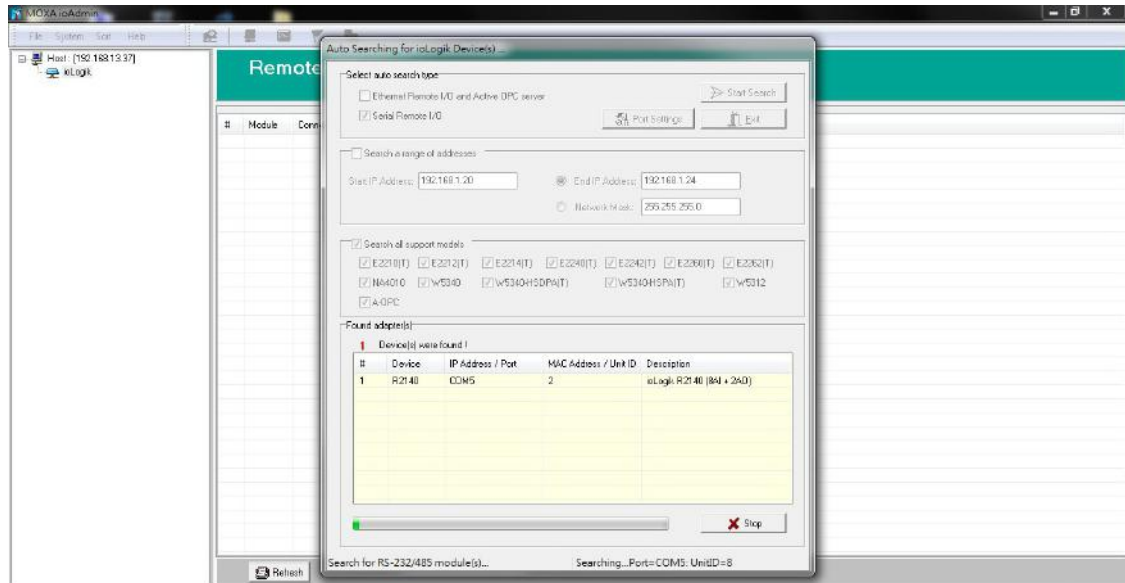

If ioAdmin is unable to find the ioLogik R2140, there may be a problem with your COM port settings. Click **Port Settings** to view or modify the settings.

4. **Monitor I/O status:** Once the unit is found by ioAdmin, you may view the status of all attached I/O devices on ioAdmin's main screen.

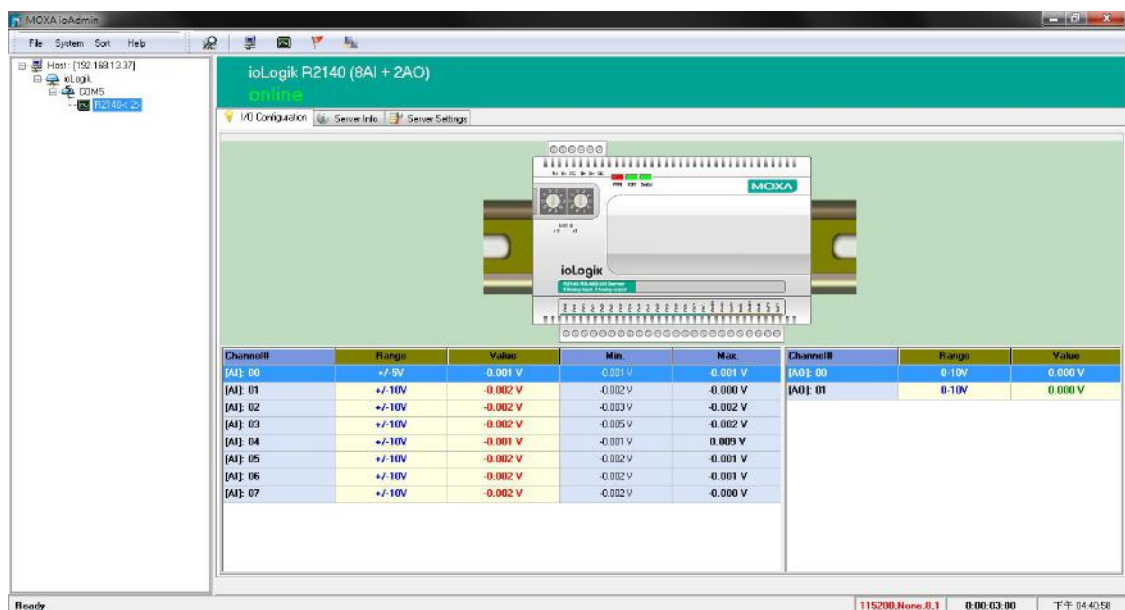

You may now use ioAdmin to setup or configure the unit.

# Using ioAdmin

---

This chapter goes over the functions available in ioAdmin, the ioLogik R2140's main configuration and management utility.

The following topics are covered in this chapter:

- ❑ **Introduction to ioAdmin**
- ❑ **Features of ioAdmin**
  - Searching for the Unit
- ❑ **ioAdmin Main Screen**
  - Main Screen Overview
  - Wiring Guide
- ❑ **Menu Items**
  - File
  - System
  - Sort
  - Help
  - Quick Links
- ❑ **Main Window**
  - I/O Configuration Tab (General)
  - Server Info Tab
  - Server Settings Tab (General)
- ❑ **ioAdmin Administrator Functions**
  - I/O Configuration Tab (Administrator)
  - Server Settings Tab (Administrator)
  - Firmware Update Tab
  - Watchdog Tab
  - Server Context Menu



# Introduction to ioAdmin

The ioLogik I/O server may be managed and configured over the Ethernet by ioAdmin, a Windows utility provided with your ioLogik R2140. ioAdmin's graphical user interface gives you easy access to all status information and settings.

ioAdmin consists of following software:

- ioAdmin
- ioLogik 2000 Wiring Guide
- ioLogik 4000 Wiring Guide

## Features of ioAdmin

### Remote Management

Over the RS-485 network, ioAdmin allows users to

- find and configure multiple ioLogik servers
- monitor and configure attached I/O devices
- test I/O devices
- reset the server

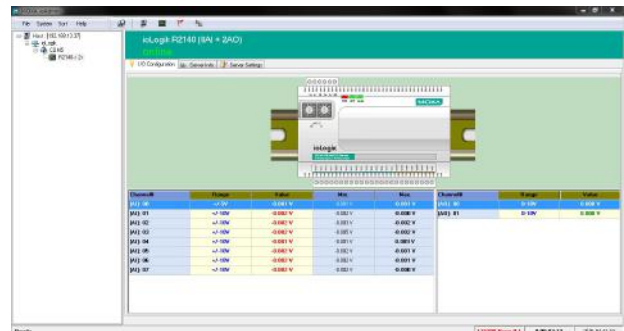

### On-line Wiring Guide

An on-line wiring guide can be opened from within ioAdmin for your convenience. The easily accessible wiring guide can save administrators much time while planning or troubleshooting.

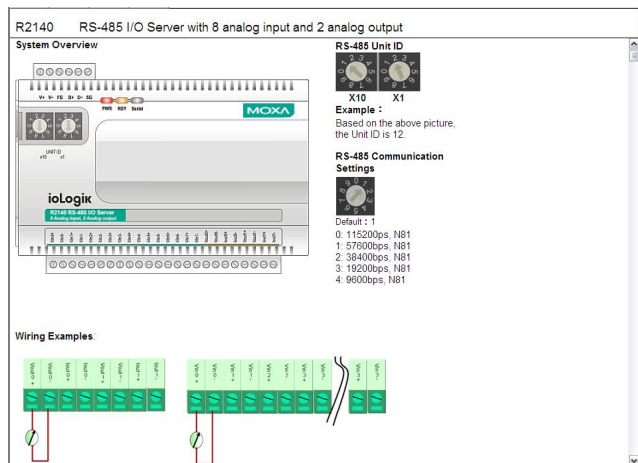

### Configuration File

ioAdmin allows the entire configuration of the ioLogik R2140 to be saved as a file. The file is viewable as text and can serve three purposes:

- as a record or backup of configuration
- as a template for the configuration of other servers
- as a quick reference guide for you to configure Modbus drivers in a SCADA system

The file includes the following information:

- file name, date, and time
- model information
- Modbus addresses

```

ioLogik R2140 Remote I/O Server Configuration
=====
Date: 2007/11/16
Time: 下午 04:17:12
Firmware: U1.2 Build07051610

[1. Model]
-----
MOD_TYPE=R2140 - RS-485 Remote I/O Server (8AI + 2AO)
MOD_LOC=
MOD_NAME=

[2. I/O Configurations]
-----
AI00=3,(+/-10V)
AI01=3,(+/-10V)
AI02=3,(+/-10V)
AI03=3,(+/-10V)
AI04=3,(+/-10V)
AI05=3,(+/-10V)
AI06=3,(+/-10V)
AI07=3,(+/-10V)

AO00=0,(0-10V),      AO00_PVN=0,(RAW),      AO00_SAFE=0,(RAW)
AO01=0,(0-10V),      AO01_PVN=0,(RAW),      AO01_SAFE=0,(RAW)

[3. Modbus address table]
-----
CHANNEL I/O TYPE      MODBUS REFERENCE      MODBUS ADDRESS (Dec, Hex)
AI00      Input      30001      0000, 0x0000
AI01      Input      30002      0001, 0x0001
AI02      Input      30003      0002, 0x0002
AI03      Input      30004      0003, 0x0003
AI04      Input      30005      0004, 0x0004
AI05      Input      30006      0005, 0x0005
AI06      Input      30007      0006, 0x0006
AI07      Input      30008      0007, 0x0007
AO00      Output     40001      0000, 0x0000
    
```

### Server Management List

ioAdmin can import and export a list of ioLogik servers that are being managed. This file can make it easier to manage all devices on the network, and includes the following information:

- server name
- module type
- IP address
- unit ID

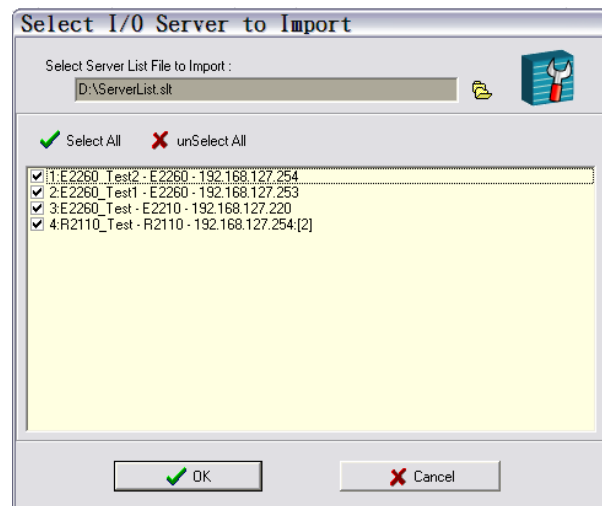

## Searching for the Unit

After opening ioAdmin, you will need to find your unit over the RS-485 connection. From the pull-down menu, choose **System - Auto Scan Remote I/O Server**.

Select **RS-232/485 I/O server** and click **Port Settings** to set/verify the serial port settings.

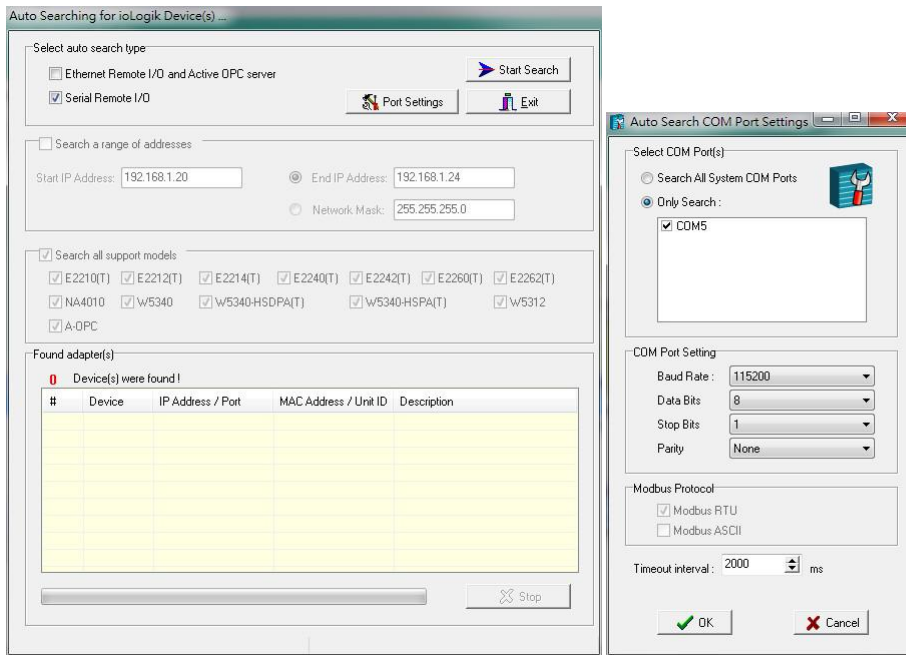

When you click **Start Search**, ioAdmin will begin searching up to 99 ports for your ioLogik unit. The timeout interval is for RS-485 communication and defaults to 2000 ms. As soon as your ioLogik R2140 appears as shown below, you may click **Stop**. Otherwise, ioAdmin will continue to search all 99 ports.



**ATTENTION**

If ioAdmin is unable to find your ioLogik R2140, make sure that the baudrates match. Please refer to Chapter 2 for setting or viewing the baudrate.



**ATTENTION**

Even if ioAdmin is unable to find your ioLogik R2140, you may still access the On-line Wiring Guide. Please refer to the On-line Wiring Guide section for details.

Once the ioLogik R2140 has been found by ioAdmin, you may monitor I/O status from the first tab of ioAdmin. You can also configure each AI and AO channel from this tab after first logging in under the Management tab.

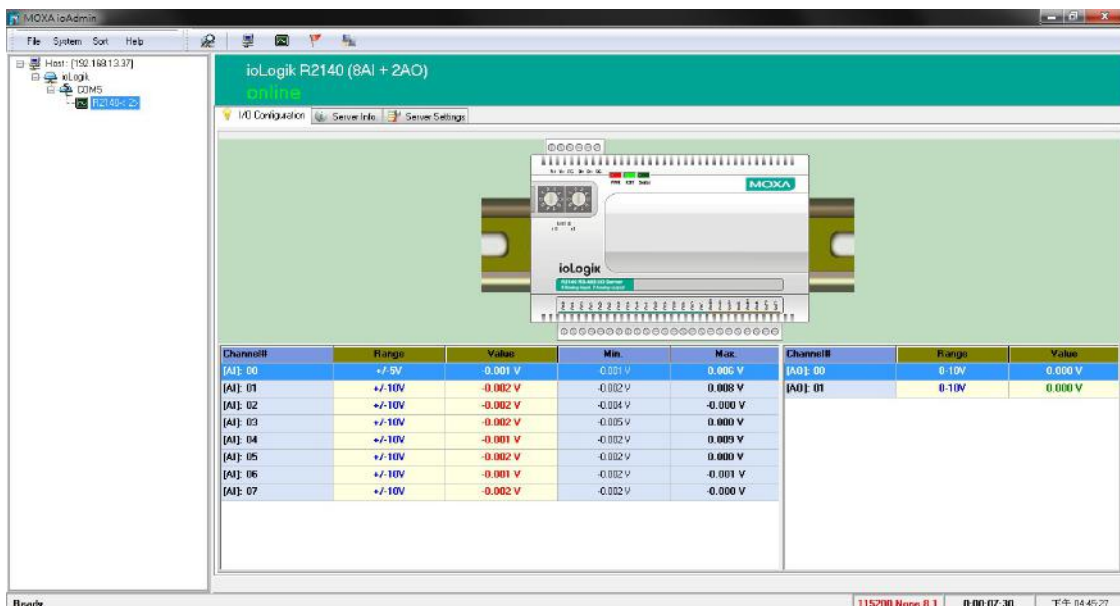

# ioAdmin Main Screen

## Main Screen Overview

This is ioAdmin's main screen. The main window defaults to the I/O Configuration tab, which displays a graphic of the ioLogik R2140 and the status of every I/O channel below it. The other tabs in the main window take you to server and network settings, and further functions are available when you log on as an administrator. Note that configuration options are not available until you log on as an administrator.

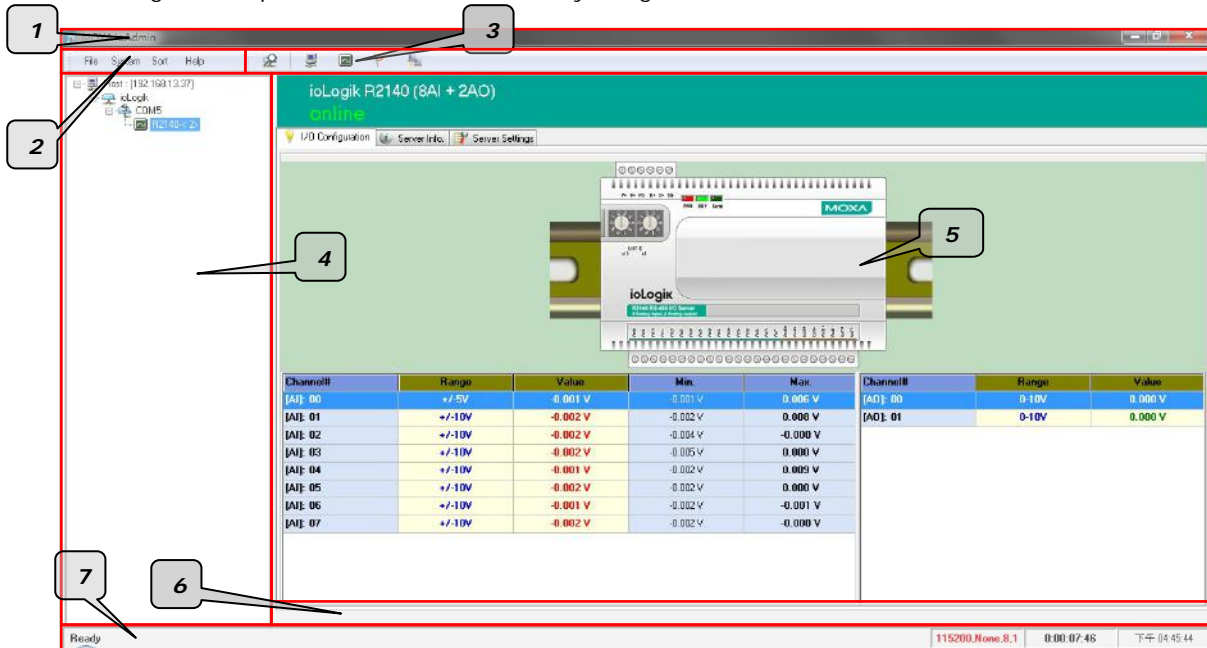

Title
1. Menu bar
2. Quick link
3. Navigation panel
4. Main window
5. Sync. rate status
6. Status bar

# Wiring Guide

ioAdmin provides a wiring guide to the ioLogik R2140. You may access the wiring guide by right-clicking the graphic of the ioLogik R2140 in the I/O Configuration tab. Select **Wiring Guide** in the submenu to open a help file showing the wiring information and electrical characteristics of the ioLogik R2140.

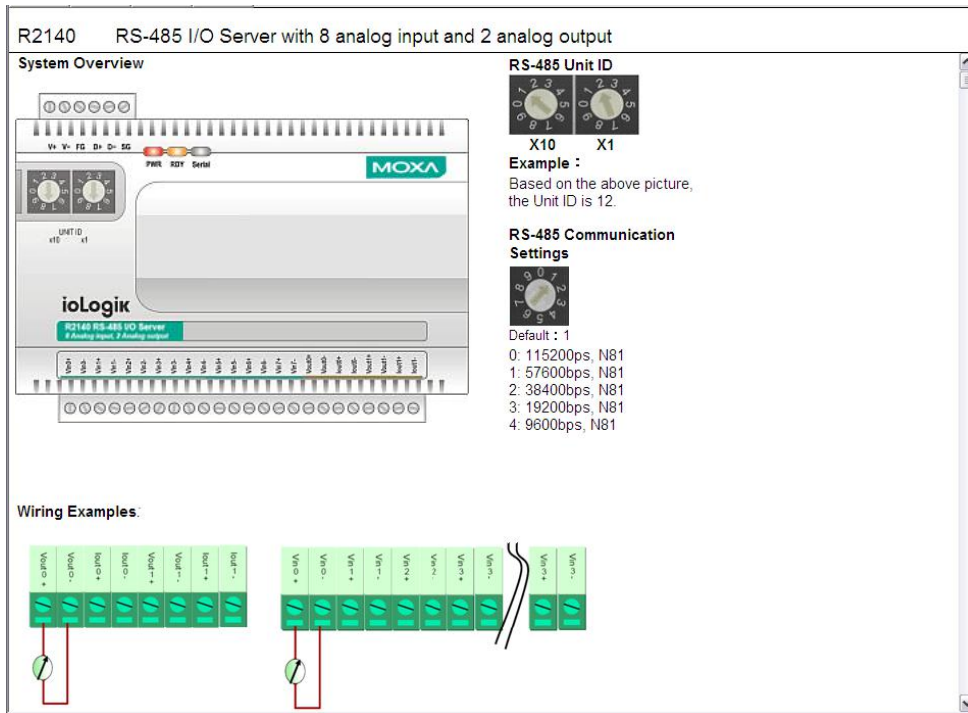

You may also access the On-line Wiring Guide through the Help menu on the menu bar.

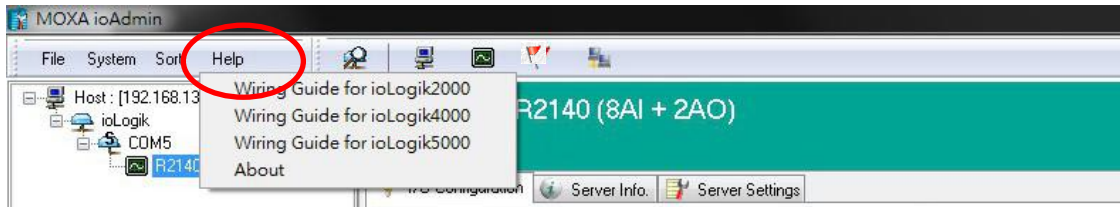

# Menu Items

## File

From the **File** menu, you can export the list of I/O servers that are currently displayed in the navigation panel. You also can import a list of I/O servers into ioAdmin.

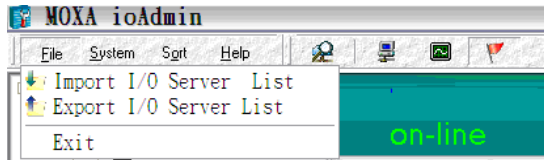

When importing a server list, you will be prompted to select which servers on the list need to be imported.

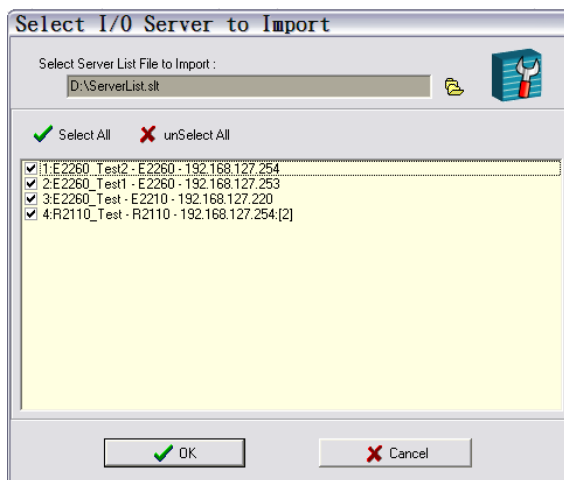

The file will have a .SLT extension and can be opened as a text file. The server list will provide the following information for each server:

- server name
- module type
- IP address
- unit ID

## System

Several operations are possible from the **System** menu.

**Auto Scan Active Ethernet I/O Server** will search for ioLogik servers on the network. When connecting for the first time or recovering from a network disconnection, you can use this command to find I/O servers that are on the network.

**Network Interface** allows you to select a network to use, if the PC has multiple network adapters installed.

**I/O Status Refresh Rate** is used to adjust how often the I/O server is polled for device status. The current rate is displayed on the status bar at the bottom of the window. Note that higher sync rates result in higher loads on the network.

**TCP Socket Timeout Interval** allows you to select the preferred timeout value for TCP socket communication.

**COM Port Setting** is used to set the parameters for Modbus communication, such as baudrate, data bits, and timeout interval. For most applications, this will involve connecting to ioLogik R-Series devices.

**Active Message Listen Port** specifies the port number to use for Active Ethernet I/O messages. If your network uses a firewall, you can coordinate this setting with your firewall settings to ensure that active messages get through.

**Reset NA4010 Network Adapter IP** is used to re-assign an IP address to the NA-4010 network adapter, for ioLogik 4000 systems.

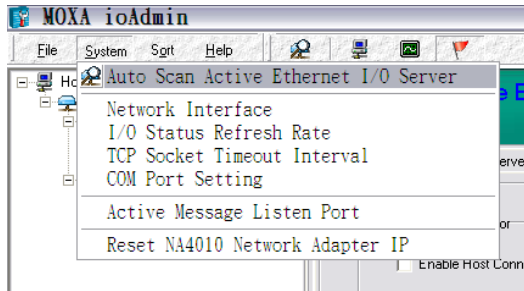

## Sort

The **Sort** menu allows the server list in the navigation panel to be sorted by connection, type, and location.

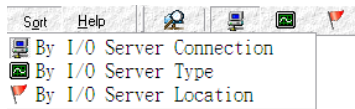

## Help



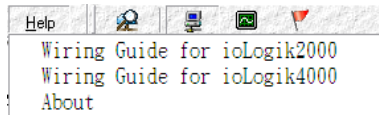

In the **Help** menu, you can view wiring guides and information about ioAdmin.



## Quick Links

Quick links are provided to search for I/O servers on the network and sort the server list.



	Search network for I/O servers
	Sort by connection
	Sort by I/O server type
	Sort by location

# Main Window

## I/O Configuration Tab (General)

The **I/O Configuration** tab shows the status of every I/O channel. This is the default tab when you first open ioAdmin.

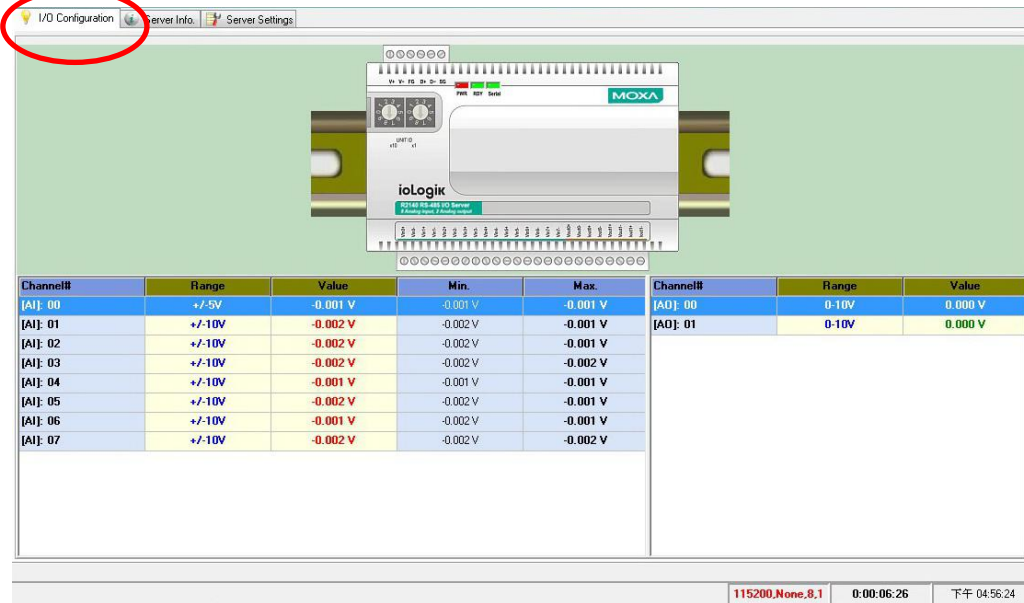

## Server Info Tab

The **Server Information** tab provides the Modbus addresses for system configuration items. This helps you verify the access authority of each address. The screen also displays a clear explanation of each item.

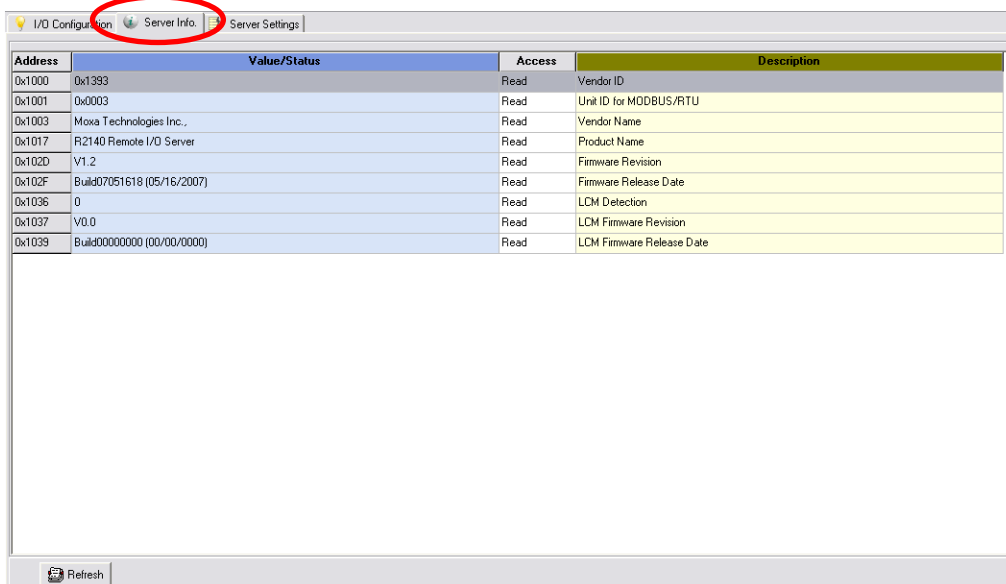



## Server Settings Tab (General)

The **Server Settings** tab is where you log in as an administrator. This is required in order to gain access to the ioLogik R2140 configuration options. If no administrator password has been set up, simply click **Login** and leave the **Password for entry** field blank. Additional information on ioAdmin administrator functions is provided later in this chapter.

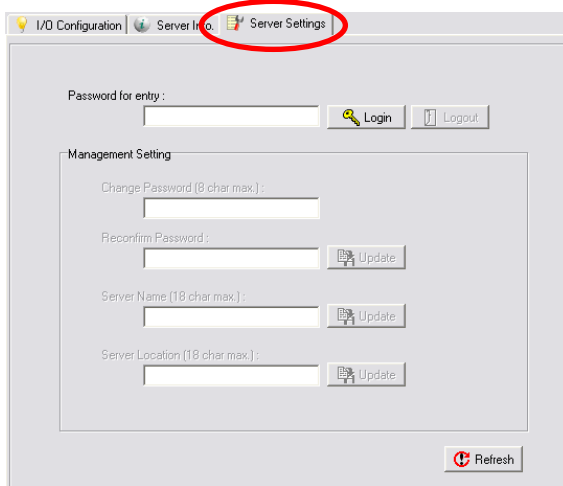

## ioAdmin Administrator Functions

For full access to all configuration options, log in as an administrator in the Server Settings tab. This is required whenever you start up ioAdmin or boot up/restart the ioLogik R2140. When you install the ioLogik R2140 for the first time, the password will be blank and you may simply click **Login**. Additional tabs and functions will be available after logging in.

When making configuration changes, you will need to click **Update** or on **Apply** to save the changes. Some changes will require a restart of the ioLogik R2140 in order to take effect, and you will be given the option to restart the computer if necessary.



### ATTENTION

You **MUST** log in to access any administrator function such as Watchdog and Firmware Update tabs. If you forget the password, you may hold down the Reset button to clear the password and load factory defaults. This will result in the loss of all configuration settings!

## I/O Configuration Tab (Administrator)

When logged on as an administrator, you may double click a channel in the **I/O Configuration** tab to configure that channel's settings.

### Configuring Analog Input Channels

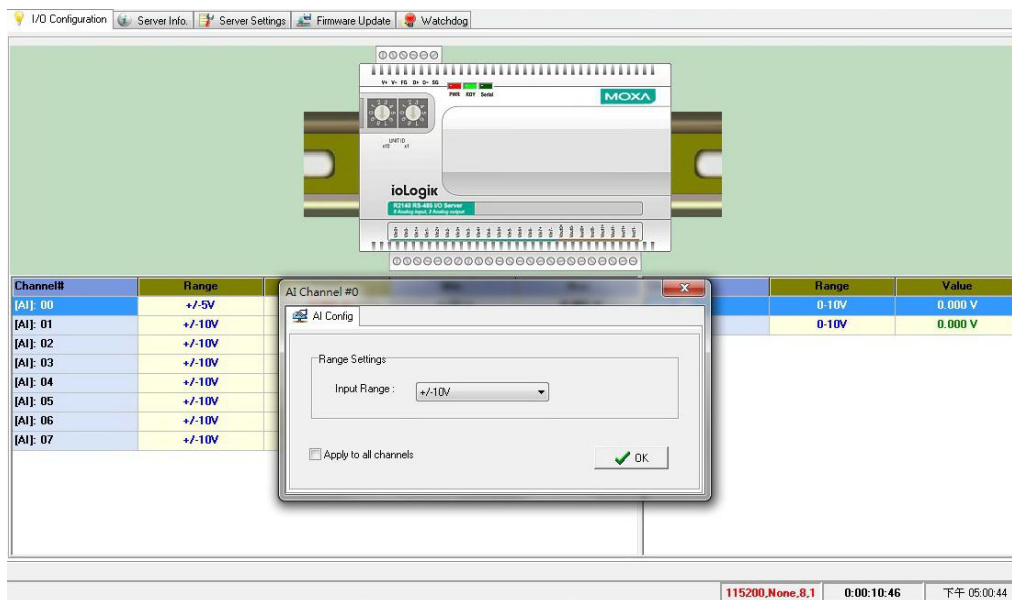

The R2140 is equipped with 8 AI (analog input) channels that can be set individually to +/-150 mV, +/-500 mV, +/-5V, +/-10V, 0-20 mA, and 4-20 mA.

### Configuring Analog Output Channels

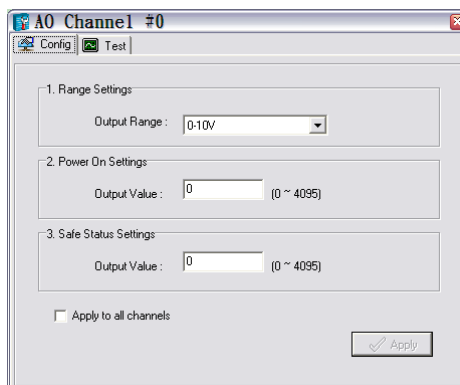

The ioLogik R2140 is equipped with 2 AO (analog output) channels that can be set individually to 0 to 10V, 4 to 20 mA.

**Power On Settings:** Use this field to set the initial status for the AO channel when the ioLogik is powered on.

**Safe Status Settings:** Use this field to specify how the AO channel responds to a break in network communication. When the network connection is lost as specified in the Host Connection Watchdog, the ioLogik R2140 will reset all channels according to their Safe Status settings. Note that the Host Connection Watchdog is disabled by default, and must be enabled for Safe Status settings to have effect.

**Test I/O:** You can test the AO channel in the **Test** tab.

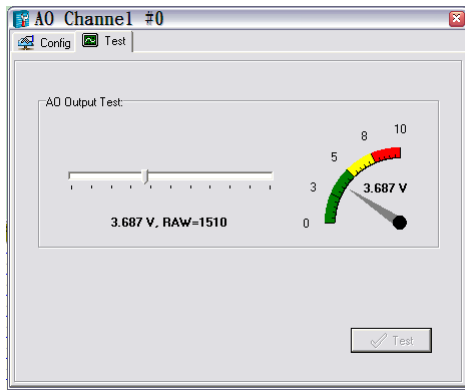

Note that the slider shows both the raw data value and the V/mA value. You may use this as a guide when entering values for the Power On and Safe Status settings.

## Server Settings Tab (Administrator)

You may set up a password, server name, location, date, time zone, and time server in the **Server Settings** tab.

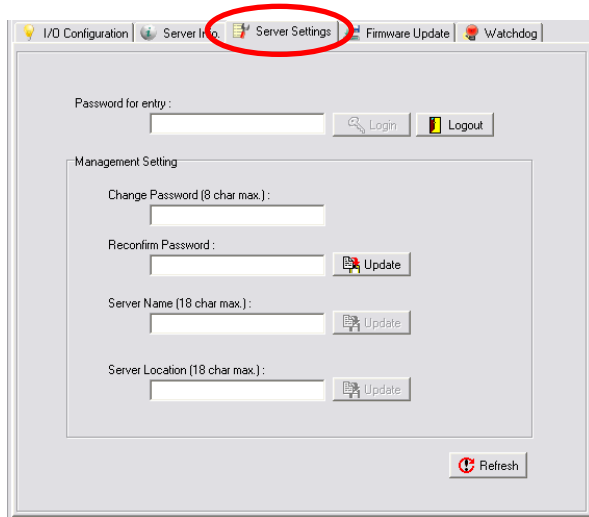

## Firmware Update Tab

The ioLogik R2140 supports remote firmware updates through the **Firmware Update** tab. Enter the path to the firmware file or click on the icon to browse for the file. Click **Update** to update the firmware. The wizard will lead you through the process until the server is restarted.

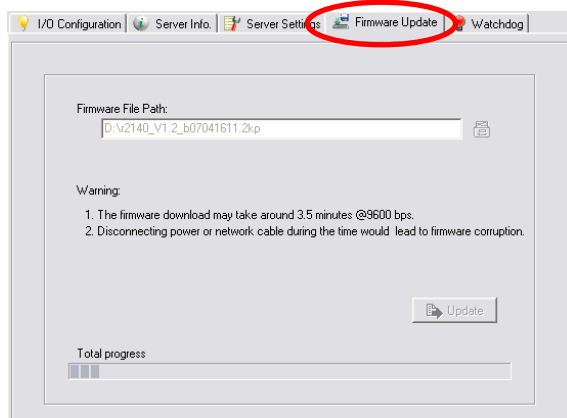



## ATTENTION

**Do not interrupt the firmware update process!** An interruption in the process may result in your device becoming unrecoverable.

After the firmware is updated, the ioLogik will restart and you will have to log in again to access administrator functions.

The firmware on any attached I/O expansion module, such as an ioLogik R2000 server, must be updated over the RS-485 bus. Firmware on cascaded modules cannot be updated over Ethernet.

## Watchdog Tab

The **Watchdog** tab is where you configure the Host Connection Watchdog, which is used with the Safe Status settings to define each channel's response to a lost network connection. When the ioLogik R2140 loses its network connection as specified in the timeout, the Host Connection Watchdog will switch the ioLogik R2140 to Safe Status and all channels will reset to their Safe Status settings. By default, the Watchdog is disabled. To enable the Watchdog, make sure **Enable Host Connection Watchdog** is checked, set the Timeout value, then click the **Update** button.

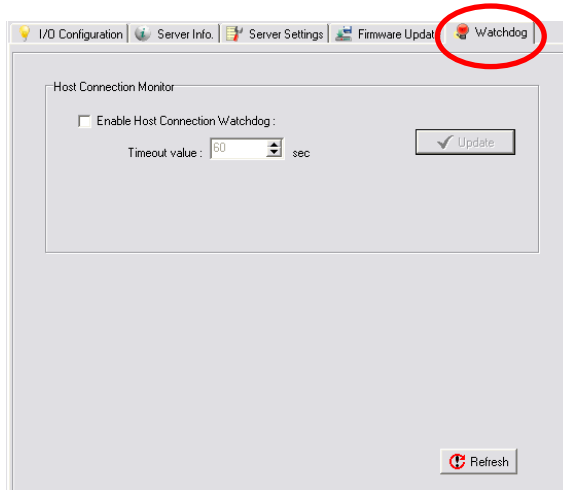

After the Watchdog is enabled, the ioLogik R2140 will enter safe status if the RS-485 connection is lost. Once the connection has been restored, you will need to return to the Watchdog Tab in order to exit safe status. There will be a message saying "Host Connection Lost", indicating that the server is in safe status. Click **Clear Alarm** to exit safe status and return to normal operation.

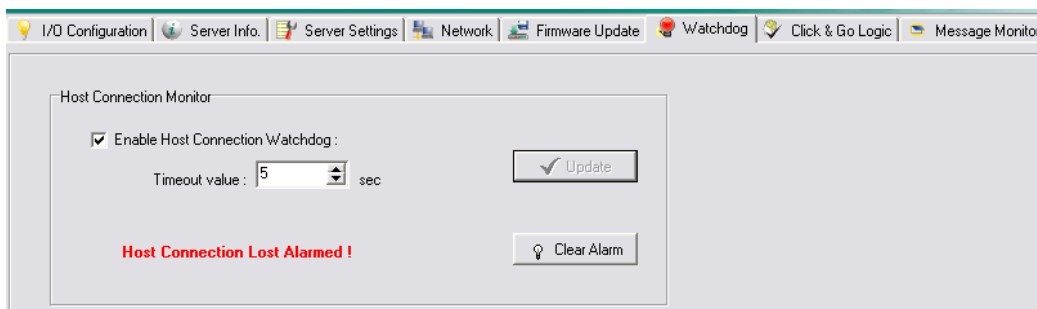

## Server Context Menu

The server context menu is accessed by right clicking on the server model name in the navigation panel.

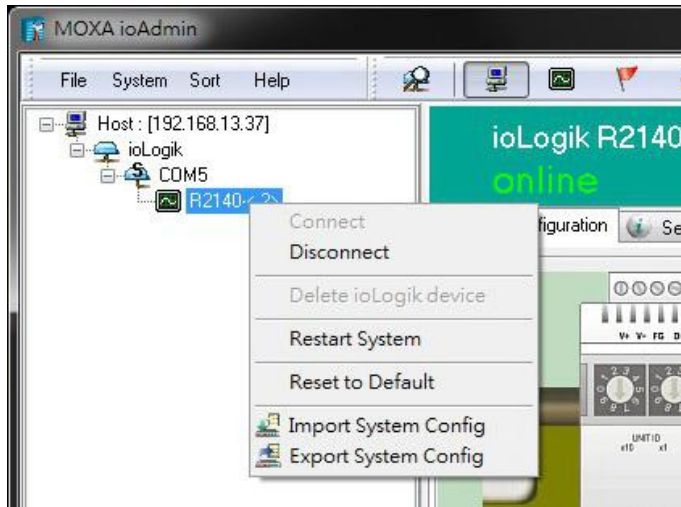

### Connect

Select this command to have ioAdmin attempt a re-connection over the network to the selected ioLogik server.

### Disconnect

Select this command to have ioAdmin drop the network connection with the selected ioLogik server.

### Delete I/O Server

Select this command to have ioAdmin remove the selected server.

### Add Serial I/O Server

Select this command to manually add a server by using its Unit ID. This function is used when cascading multiple I/O servers over RS-485.

### Restart System

Select this command to restart the ioLogik from a remote site. You will need to log in as an administrator to use this function.

### Reset to Default

Select this command to reset all settings, including console password, to factory default values. You will need to log in as an administrator to use this function.

### Export System Config

Select this command to export the configuration of the ioLogik to a text file. You will need to log in as an administrator to use this function. It is strongly recommended you use this method to back up your configuration after you have finished configuring the ioLogik for your application.

## Import System Config

Select this command to reload a configuration that was exported to a text file. You will need to restart the ioLogik in order for the new configuration to take effect. This command may be used to restore a configuration after loading the factory defaults, or to duplicate a configuration to multiple ioLogik units.

# Cascading with Other I/O Servers

---

The ioLogik R2140 can act both as a standalone I/O server and as an extension module to other I/O servers. This chapter explains how to use the ioLogik R2 140 as an extension module to ioLogik E2000 I/O servers.

The following topics are covered in this chapter:

- ❑ **Introductino**
- ❑ **Cascading System Bus**
- ❑ **Hardware Installation**
- ❑ **Using ioAdmin with Cascaded I/O Servers**
  - Adding One I/O Server
  - Adding Two or More I/O Servers
  - Removing Cascaded I/O Servers
- ❑ **Limitations**

# Introductino

The ioLogik R2140 can serve as an extension module to provide additional I/O channels to an ioLogik E2210 or E2240 Ethernet I/O server. Up to 31 units can be chained or cascaded together using each unit's built-in connectors.

## Cascading System Bus

The I/O servers connect to each other over the cascading system bus, which uses RS-485 and Modbus protocols. Pin assignments for the female system bus connector are shown below. This is the connector that protrudes from the right side of the unit.

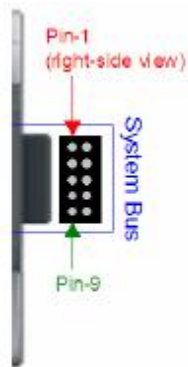

<b>Pin</b>	1	2	3	4	5
<b>Signal</b>	V+	V-	V+	V-	NC

<b>Pin</b>	6	7	8	9	10
<b>Signal</b>	NC	Data+	SYNC	Data-	GND

## Hardware Installation

To install the ioLogik R2140 as an extension module, simply snap it into place alongside the ioLogik E2000 and the two units will lock together. Press the release button to detach the unit.



Power is provided through the ioLogik E2000's system bus. Depending on the power requirements of your application, external power can also be supplied to the unit through the unit's power terminals.



# Using ioAdmin with Cascaded I/O Servers

## Adding One I/O Server

ioAdmin can be used to access the I/O channels of all cascaded I/O servers. In the following instructions, the ioLogik E2210 and R2140 are used as examples:

1. Verify that the E2210 has been installed and has been opened in ioAdmin. Snap the E2210 and R2140 together. Set the unit ID for the R2140 starting from "2".
2. In ioAdmin, right-click the E2210 in the navigation panel and select **"Add Serial I/O Server"** in the context menu.

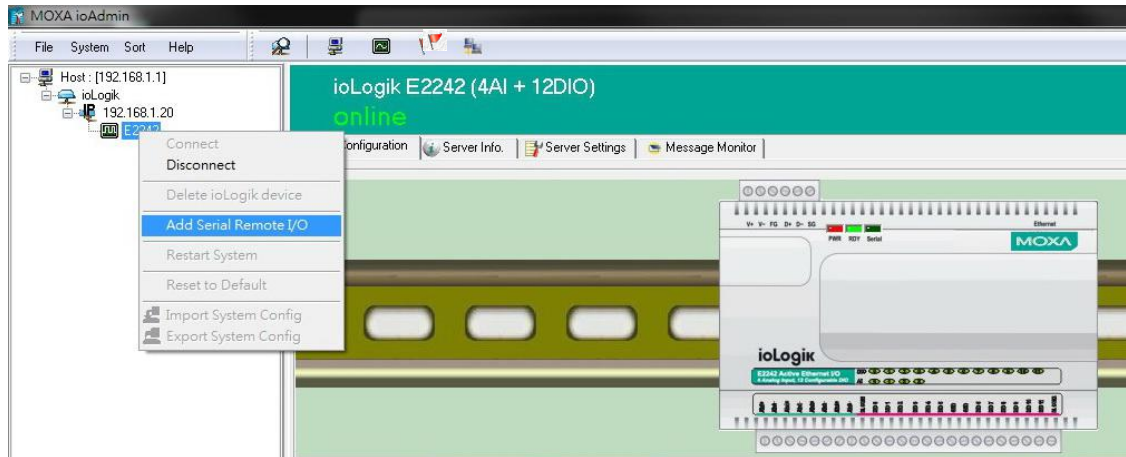

3. Select the appropriate I/O Server type and UnitID ("R2140 RS-485" and "3" in this example). Click **"Add"**.

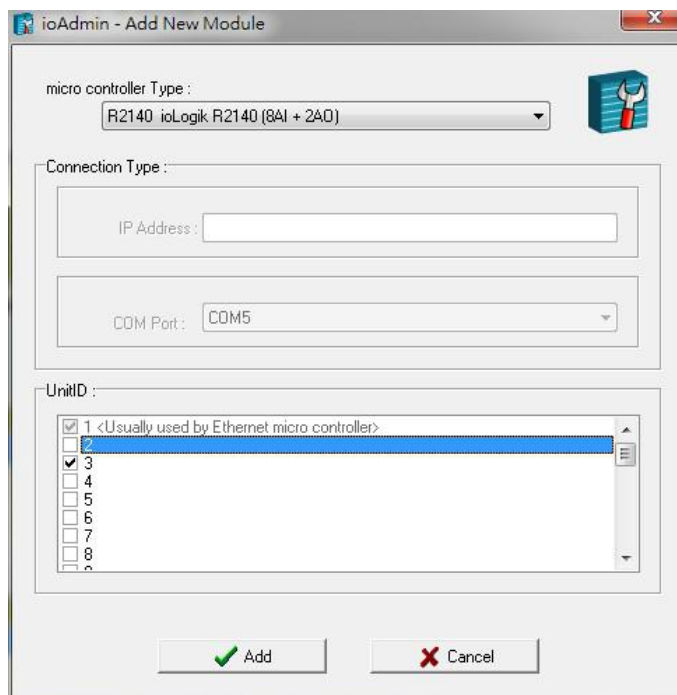

- The R2140 will appear with its unit ID under the E2210 in ioAdmin's navigation panel. If the R2140 appears off-line, open its context menu in the navigation panel and select **Connect** to bring it on-line. Once the R2140 is on-line, you will be able to use ioAdmin to monitor and control its I/O channels.

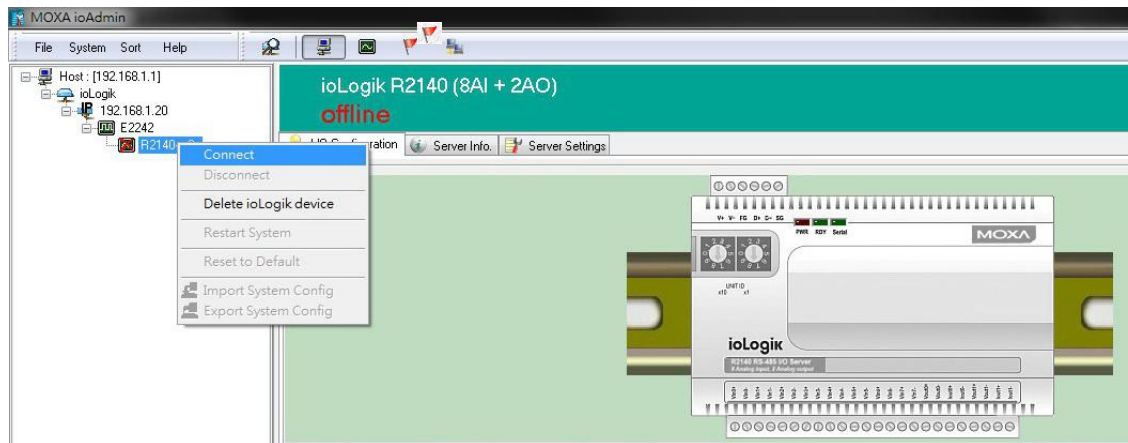

## Adding Two or More I/O Servers

Multiple I/O servers can be cascaded together for even more I/O channels. The following instructions show how multiple cascaded I/O servers are accessed in ioAdmin, using the ioLogik E2210, R2110, and R2140 as examples:

- Verify that the E2210 has been installed and has been opened in ioAdmin. Snap the R2110 onto the E2210, then snap the R2140 onto the R2110. Set the unit IDs for the R2110 and R2140.
- In ioAdmin, right-click the E2210 in the navigation panel and select **Add Serial I/O Server** in the context menu.
- Select the appropriate I/O Server type and UnitID. Click **Add**.
- Repeat steps 2 and 3 using the appropriate selections for the R2140.
- Both the R2110 and R2140 will appear with their unit IDs under the E2210 in ioAdmin's navigation panel. If a server appears off-line, open its context menu in the navigation panel and select **Connect** to bring it on-line. Once all I/O servers are on-line, you will be able to use ioAdmin to monitor and control each server's I/O channels.



## Removing Cascaded I/O Servers

To remove a cascaded I/O server in ioAdmin, right-click the desired server in the navigation panel and select **Delete I/O Server** in the context menu.

## Limitations

There are some limitations when using the ioLogik R2140 as an extension module to ioLogik E2000 servers. Although each I/O channel on a cascaded module can be monitored and controlled over Ethernet, the cascaded module will not support the following items:

- Click&Go
- Active messaging
- SNMP trap messages
- E-mail messages
- Upgrade firmware

# Liquid Crystal Display Module (LCM)

The ioLogik R2140 supports an optional detachable liquid crystal display module (LCM) for easier field maintenance. The LCM is hot-pluggable and can be used to configure the network settings or display other settings. When plugged in, the module displays the ioLogik R2140 "home page," and pressing any button takes you into the settings and configuration.

## LCM Controls

The up and down buttons navigate between the current options. The right and left buttons enter and exit the submenu. The center button is used when modifying settings or restarting the server.

Button	Function
Up	go to the previous item
Down	go to the next item
Left	exit the current submenu and return to the previous menu (go up one level)
Right	enter the selected submenu (go down one level)
Center	enter/exit editing mode

An "e" in the upper right hand corner of the display indicates that the parameter can be modified. Press the center button on the LCM to modify that parameter's settings.

## LCM Options

Display	Explanation / Actions
ioLogik R2140 ID:01 Bps:115200	This is the default "home page" showing the IP address. Press the down button to view the submenus.
<ioLogik R2140> server	Enter this submenu to display information about the specific server you are viewing: <ul style="list-style-type: none"> <li>• serial number</li> <li>• name</li> <li>• location</li> <li>• R2140 f/w ver</li> <li>• display module f/w ver</li> <li>• model name</li> </ul>
<ioLogik R2140> serial port	Enter this submenu to display the RS-485 serial communication port settings: <ul style="list-style-type: none"> <li>• RS-485 Setting: 115200,n,8,1</li> </ul>
<ioLogik R2140> i/o setting	Enter this submenu to access I/O channel status. Press up or down to navigate through the different I/O channels without having to go back to the previous menu.
<ioLogik R2140> save/restart	Enter this submenu to display the <b>restart now</b> submenu. Enter the <b>restart now</b> submenu to display the <b>restart</b> option. Press the center button to modify this option, then select <b>enable</b> to save changes and reboot the I/O server. The <b>disable</b> option has no effect.



**ATTENTION**

Any configuration changes that are made through the LCM will not take effect until the ioLogik R2140 is restarted.

## Modbus/RTU Address Mappings

---

### R2140 Modbus Mapping

#### 0xxxx Read/Write Coils (Functions 1, 5, 15)

Reference	Address	Data Type	Description
00001	0x0000	1bit	Reset CH0 AI min value Read: 0: no action Write: 1: reset AI min value 0: return illegal data value
00002	0x0001	1bit	Reset CH1 AI min value Read: 0: no action Write: 1: reset AI min value 0: return illegal data value
00003	0x0002	1bit	Reset CH2 AI min value Read: 0: no action Write: 1: reset AI min value 0: return illegal data value
00004	0x0003	1bit	Reset CH3 AI min value Read: 0: no action Write: 1: reset AI min value 0: return illegal data value
00005	0x0004	1bit	Reset CH4 AI min value Read: 0: no action Write: 1: reset AI min value 0: return illegal data value
00006	0x0005	1bit	Reset CH5 AI min value Read: 0: no action Write: 1: reset AI min value 0: return illegal data value

Reference	Address	Data Type	Description
00007	0x0006	1bit	Reset CH6 AI min value Read: 0: no action Write: 1: reset AI min value 0: return illegal data value
00008	0x0007	1bit	Reset CH7 AI min value Read: 0: no action Write: 1: reset AI min value 0: return illegal data value
00009	0x0008	1bit	Reset CH0 AI max value Read: 0: no action rite: w1: reset AI max value 0: return illegal data value
00010	0x0009	1bit	Reset CH1 AI max value Read: 0: no action Write: 1: reset AI max value 0: return illegal data value
00011	0x000A	1bit	Reset CH2 AI max value Read: 0: no action Write: 1: reset AI max value 0: return illegal data value
00012	0x000B	1bit	Reset CH3 AI max value Read: 0: no action Write: 1: reset AI max value 0: return illegal data value
00013	0x000C	1bit	Reset CH4 AI max value Read: 0: no action Write: 1: reset AI max value 0: return illegal data value
00014	0x000D	1bit	Reset CH5 AI max value Read: 0: no action Write: 1: reset AI max value 0: return illegal data value

Reference	Address	Data Type	Description
00015	0x000E	1bit	Reset CH6 AI max value Read: 0: no action Write: 1: reset AI max value 0: return illegal data value
00016	0x000F	1bit	Reset CH7 AI max value Read: 0: no action Write: 1: reset AI max value 0: return illegal data value

### 3xxxx Read Only Registers (Function 4)

Reference	Address	Data Type	Description
30001	0x0000	1 word	CH0 read AI value
30002	0x0001	1 word	CH1 read AI value
30003	0x0002	1 word	CH2 read AI value
30004	0x0003	1 word	CH3 read AI value
30005	0x0004	1 word	CH4 read AI value
30006	0x0005	1 word	CH5 read AI value
30007	0x0006	1 word	CH6 read AI value
30008	0x0007	1 word	CH7 read AI value
30009	0x0008	1 word	CH0 read AI min value
30010	0x0009	1 word	CH1 read AI min value
30011	0x000A	1 word	CH2 read AI min value
30012	0x000B	1 word	CH3 read AI min value
30013	0x000C	1 word	CH4 read AI min value
30014	0x000D	1 word	CH5 read AI min value
30015	0x000E	1 word	CH6 read AI min value
30016	0x000F	1 word	CH7 read AI min value
30017	0x0010	1 word	CH0 read AI max value
30018	0x0011	1 word	CH1 read AI max value
30019	0x0012	1 word	CH2 read AI max value
30020	0x0013	1 word	CH3 read AI max value
30021	0x0014	1 word	CH4 read AI max value
30022	0x0015	1 word	CH5 read AI max value
30023	0x0016	1 word	CH6 read AI max value
30024	0x0017	1 word	CH7 read AI max value



## 4xxxx Read/Write Registers (Functions 3, 6, 16)

Reference	Address	Data Type	Description
40001	0x0000	1 word	CH0 AO value (0 to 4095)
40002	0x0001	1 word	CH1 AO value (0 to 4095)
40003	0x0002	1 word	CH0 AO power-on value (0 to 4095)
40004	0x0003	1 word	CH1 AO power-on value (0 to 4095)
40005	0x0004	1 word	CH0 AO safe value (0 to 4095)
40006	0x0005	1 word	CH1 AO safe value (0 to 4095)
40007	0x0006	1 word	CH0 AO range 0: 0-10 VDC 1: 4-20 mA Other: return illegal data value
40008	0x0007	1 word	CH1 AO range 0: 0-10 VDC 1: 4-20 mA Other: return illegal data value
40009	0x0008	1 word	CH0 AO power-on range 0: 0-10 VDC 1: 4-20 mA Other: return illegal data value
40010	0x0009	1 word	CH1 AO power-on range 0: 0-10 VDC 1: 4-20 mA Other: return illegal data value
40011	0x000A	1 word	CH0 AO safe range 0: 0-10 VDC 1: 4-20 mA Other: return illegal data value
40012	0x000B	1 word	CH1 AO safe range 0: 0-10 VDC 1: 4-20 mA Other: return illegal data value
40013	0x000C	1 word	CH0 AI range 00: +/-150 mV 01: +/-500 mV 02: +/-5V 03: +/-10V 04: 0-20 mA 05: 4-20 mA Other: return illegal data value
40014	0x000D	1 word	CH1 AI range 00: +/-150 mV 01: +/-500 mV 02: +/-5V 03: +/-10V 04: 0-20 mA 05: 4-20 mA Other: return illegal data value

Reference	Address	Data Type	Description
40015	0x000E	1 word	CH2 AI range 00: +/-150 mV 01: +/-500 mV 02: +/-5V 03: +/-10V 04: 0-20 mA 05: 4-20 mA Other: return illegal data value
40016	0x000F	1 word	CH3 AI range 00: +/-150 mV 01: +/-500 mV 02: +/-5V 03: +/-10V 04: 0-20 mA 05: 4-20 mA Other: return illegal data value
40017	0x001 0	1 word	CH4 AI range 00: +/-150 mV 01: +/-500 mV 02: +/-5V 03: +/-10V 04: 0-20 mA 05: 4-20 mA Other: return illegal data value
40018	0x001 1	1 word	CH5 AI range 00: +/-150 mV 01: +/-500 mV 02: +/-5V 03: +/-10V 04: 0-20 mA 05: 4-20 mA Other: return illegal data value
40019	0x0012	1 word	CH6 AI range 00: +/-150 mV 01: +/-500 mV 02: +/-5V 03: +/-10V 04: 0-20 mA 05: 4-20 mA Other: return illegal data value
40020	0x001 3	1 word	CH7 AI range 00: +/-150 mV 01: +/-500 mV 02: +/-5V 03: +/-10V 04: 0-20 mA 05: 4-20 mA Other: return illegal data value

Reference	Address	Data Type	Description
40021	0x0014	1 word	CH0 AI power-on range 00: +/-150 mV 01: +/-500 mV 02: +/-5V 03: +/-10V 04: 0-20 mA 05: 4-20 mA Other: return illegal data value
40022	0x0015	1 word	CH1 AI power-on range 00: +/-150 mV 01: +/-500 mV 02: +/-5V 03: +/-10V 04: 0-20 mA 05: 4-20 mA Other: return illegal data value
40023	0x0016	1 word	CH2 AI power-on range 00: +/-150 mV 01: +/-500 mV 02: +/-5V 03: +/-10V 04: 0-20 mA 05: 4-20 mA Other: return illegal data value
40024	0x0017	1 word	CH3 AI power-on range 00: +/-150 mV 01: +/-500 mV 02: +/-5V 03: +/-10V 04: 0-20 mA 05: 4-20 mA Other: return illegal data value
40025	0x0018	1 word	CH4 AI power-on range 00: +/-150 mV 01: +/-500 mV 02: +/-5V 03: +/-10V 04: 0-20 mA 05: 4-20 mA Other: return illegal data value
40026	0x0019	1 word	CH5 AI power-on range 00: +/-150 mV 01: +/-500 mV 02: +/-5V 03: +/-10V 04: 0-20 mA 05: 4-20 mA Other: return illegal data value

Reference	Address	Data Type	Description
40027	0x001A	1 word	CH6 AI power-on range 00: +/-150 mV 01: +/-500 mV 02: +/-5V 03: +/-10V 04: 0-20 mA 05: 4-20 mA Other: return illegal data value
40028	0x001B	1 word	CH7 AI power-on range 00: +/-150 mV 01: +/-500 mV 02: +/-5V 03: +/-10V 04: 0-20 mA 05: 4-20 mA Other: return illegal data value
40029	0x001C	1 word	CH0 AI safe range 00: +/-150 mV 01: +/-500 mV 02: +/-5V 03: +/-10V 04: 0-20 mA 05: 4-20 mA Other: return illegal data value
40030	0x001D	1 word	CH1 AI safe range 00: +/-150 mV 01: +/-500 mV 02: +/-5V 03: +/-10V 04: 0-20 mA 05: 4-20 mA Other: return illegal data value
40031	0x001E	1 word	CH2 AI safe range 00: +/-150 mV 01: +/-500 mV 02: +/-5V 03: +/-10V 04: 0-20 mA 05: 4-20 mA Other: return illegal data value
40032	0x001F	1 word	CH3 AI safe range 00: +/-150 mV 01: +/-500 mV 02: +/-5V 03: +/-10V 04: 0-20 mA 05: 4-20 mA Other: return illegal data value

Reference	Address	Data Type	Description
40033	0x0020	1 word	CH4 AI safe range 00: +/-150 mV 01: +/-500 mV 02: +/-5V 03: +/-10V 04: 0-20 mA 05: 4-20 mA Other: return illegal data value
40034	0x0021	1 word	CH5 AI safe range 00: +/-150 mV 01: +/-500 mV 02: +/-5V 03: +/-10V 04: 0-20 mA 05: 4-20 mA Other: return illegal data value
40035	0x0022	1 word	CH6 AI safe range 00: +/-150 mV 01: +/-500 mV 02: +/-5V 03: +/-10V 04: 0-20 mA 05: 4-20 mA Other: return illegal data value
40036	0x0023	1 word	CH7 AI safe range 00: +/-150 mV 01: +/-500 mV 02: +/-5V 03: +/-10V 04: 0-20 mA 05: 4-20 mA Other: return illegal data value

## Function 8

Sub-function	Data Field (Request)	Data Field (Response)	Description
0x0001	0x0000	Echo Request Data	Reboot
0x0001	0xFF00	Echo Request Data	Reset to factory defaults

## Factory Default Settings

---

The ioLogik R2140 is configured with the following factory defaults:

<b>RS-485 Unit ID</b>	1
<b>Baudrate</b>	115200 Kbps
<b>Communication Watchdog</b>	Disable
<b>AI Input Range</b>	-10 to 10V
<b>AO Output Range</b>	0 to 10V
<b>AO Safe Status</b>	Off, 0V
<b>Power On Status</b>	Off, 0V
<b>Password</b>	NONE
<b>Module Name</b>	NONE
<b>Module Location</b>	NONE

# D

## Pinouts and Cable Wiring

---

### Pin Assignments

#### System Bus

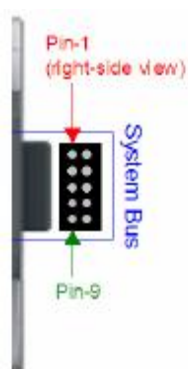

Pin	1	2	3	4	5
Signal	V+	V-	V+	V-	NC

Pin	6	7	8	9	10
Signal	NC	Data+	SYNC	Data-	GND

#### TB1 and TB2 (Power Input & RS-485 Connector)

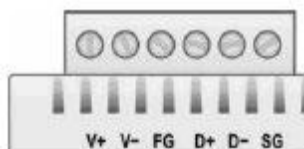

	TB1 (Power Input)			TB2 (RS-485)		
Pin	1	2	3	4	5	6
Signal	V+	V-	FG	D+	D-	SG

NOTE: FG is Frame Ground, SG is Signal Ground

### TB3 (Analog Input and Output Terminal)

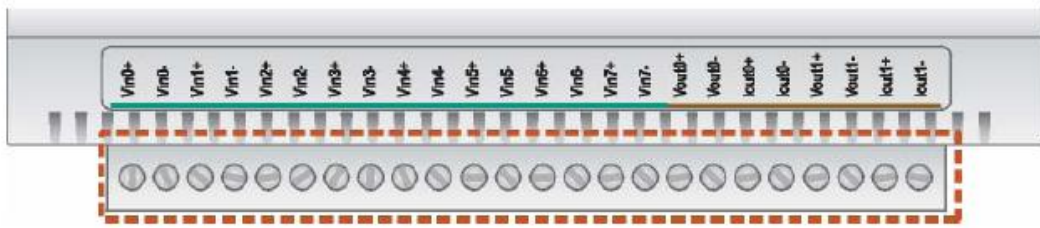

<b>Pin</b>	1	2	3	4	5	6	7	8	9
<b>Signal</b>	VIN0+	VIN0-	VIN1+	VIN1-	VIN2+	VIN2-	VIN3+	VIN3-	VIN4+

<b>Pin</b>	10	11	12	13	14	15	16	17	18
<b>Signal</b>	VIN4-	VIN5+	VIN5-	VIN6+	VIN6-	VIN7+	VIN7-	VOUT0+	VOUT0-

<b>Pin</b>	19	20	21	22	23	24			
<b>Signal</b>	IOUT 0+	IOUT 0-	VOUT1+	VOUT1-	IOUT 1+	IOUT 1-			

### Analog Output

#### Schematic

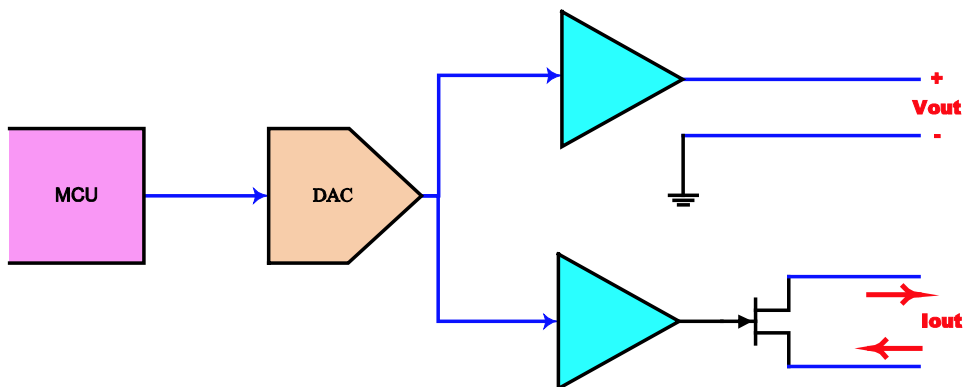

#### Connection

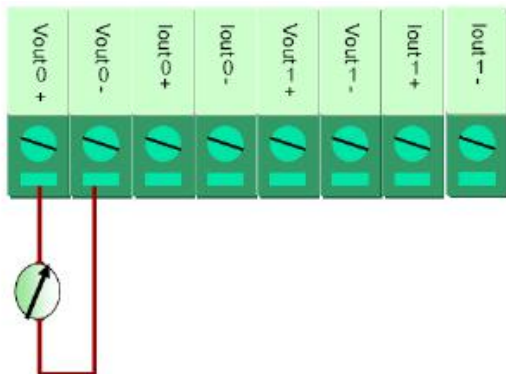



# Analog Input

## Voltage Mode Schematic

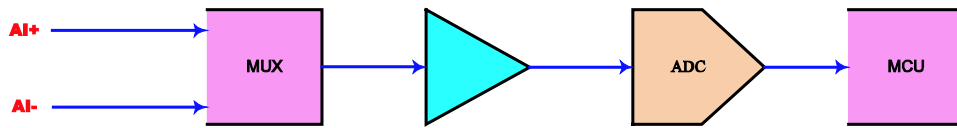

## Current Mode Schematic

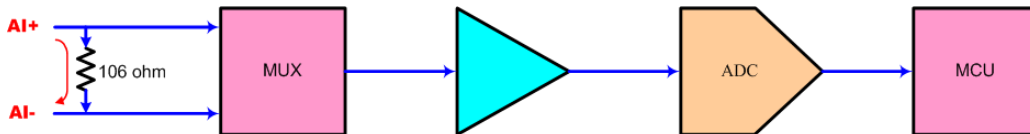

## Connection

