

# **EDS-510E Series Hardware Installation Guide**

---

**Moxa EtherDevice™ Switch**

**First Edition, July 2013**



© 2013 Moxa Inc. All rights reserved.

**P/N: 1802005100040**

## Package Checklist

The EDS-510E is shipped with the following items. If any of these items are missing or damaged, please contact your customer service representative for assistance.

- 1 EDS-510E Ethernet switch
- Hardware installation guide
- Documentation and software CD
- Moxa product warranty statement
- USB cable
- Protective caps for unused ports

## Features

- 2 Gigabit Ethernet ports for redundant ring and 1 Gigabit Ethernet port for uplink solution
- Turbo Ring and Turbo Chain (recovery time < 20 ms @ 250 switches), RSTP/STP, and MSTP for network redundancy
- RADIUS, TACACS+, SNMPv3, IEEE 802.1x, HTTPS, and SSH to enhance network security
- EtherNet/IP, PROFINET, and Modbus/TCP protocols supported for device management and monitoring

# Panel Views of EDS-510E

## Front Panel

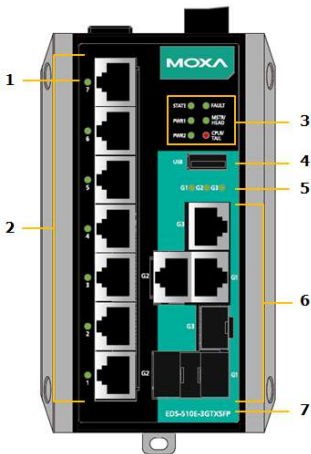

## Front Panel

- 1 to 7 port status LED
- 1 to 7: 10/100BaseT(X) port
- System status LED:
  - STATE LED indicator
  - PWR1 LED indicator
  - PWR2 LED indicator
  - FAULT LED indicator
  - MSTR/HEAD LED indicator
  - CPLR/TAIL LED indicator
- USB storage port
- G1 to G3 port status LED
- G1 to G3: 10/100/1000BaseT(X) or 100/1000BaseSFP combo port
- Model Name

## Top Panel

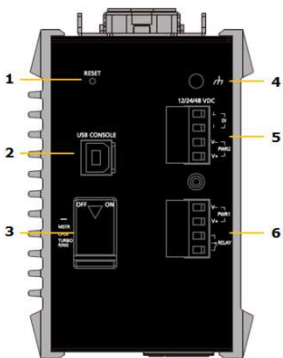

## Top Panel

- Reset button
- USB console port
- DIP switches for Turbo Ring, Ring Master, and Ring Coupler
- Grounding screw
- 4-pin terminal block for digital input and power input 2
- 4-pin terminal block for relay output and power input 1

## Rear Panel

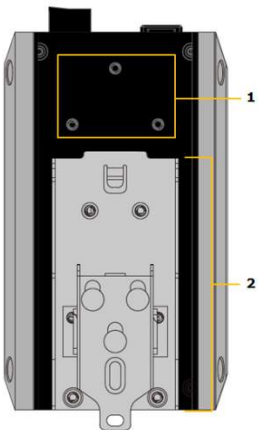

## Rear Panel

- Screw holes for wall mounting kit
- DIN-Rail mounting kit

# Mounting Dimensions

Unit = mm (inch)

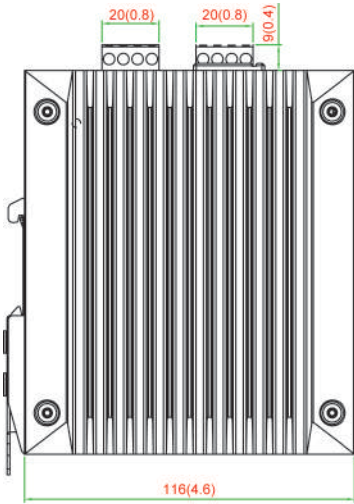

Side View

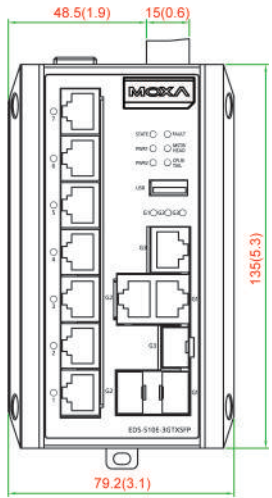

Front View

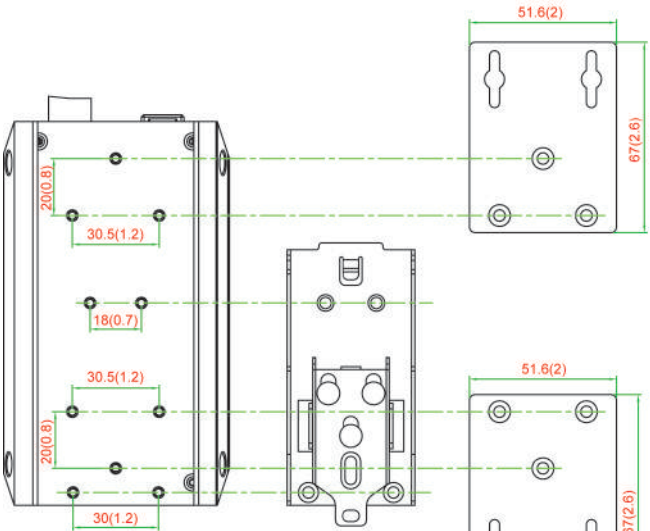

Rear View

DIN-Rail / Wall Mounting Kit

## DIN-Rail Mounting

The metal DIN-rail kit is fixed to the back panel of the EDS-510E when you take it out of the box. Mount the EDS-510E on corrosion-free mounting rails that meet the EN 60715 standard.

### Installation

**STEP 1**—Insert the upper lip of the DIN rail into the DIN-rail mounting kit.

**STEP 2**—Press the EDS-510E towards the DIN rail until it snaps into place.

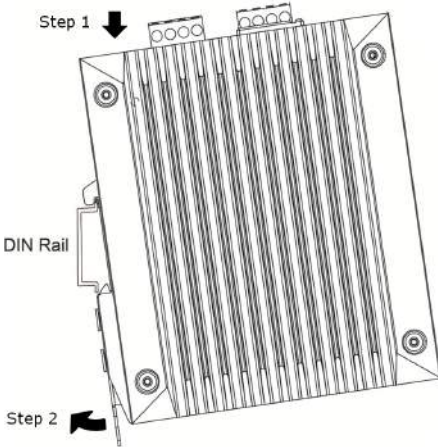

### Removal

**STEP 1**—Pull down the latch on the mounting kit with a screwdriver.

**STEP 2 & 3**—Slightly pull the EDS-510E forward and lift up to remove it from the DIN rail.

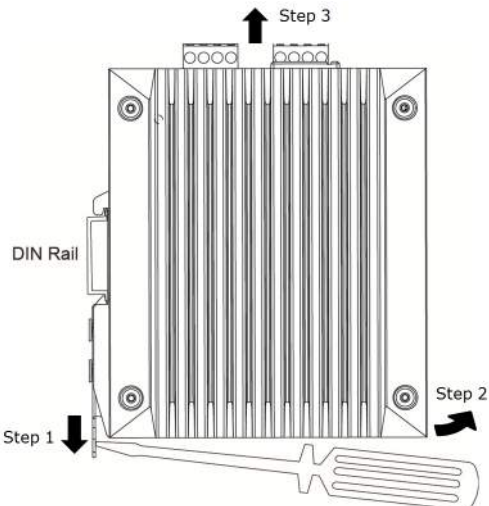

## Wall Mounting (Optional)

For some applications, you will find it convenient to mount Moxa EDS-510E on the wall, as shown in the following illustrations:

**STEP 1**—Remove the aluminum DIN rail attachment plate from the rear panel of the EDS-510E, and then attach the wall mount plates with M3 screws, as shown in the figure at the right.

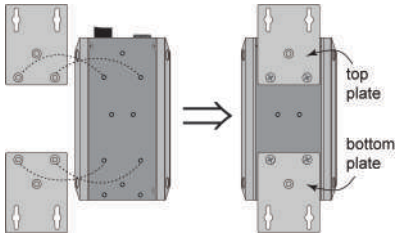

**STEP 2**—Mounting the EDS-510E on the wall requires 4 screws. Use the EDS-510E, with wall mount plates attached, as a guide to mark the correct locations of the 4 screws. The heads of the screws should be less than 6.0 mm in diameter, and the shafts should be less than 3.5 mm in diameter, as shown in the figure on at right.

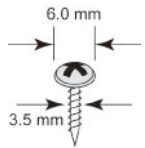

**NOTE** Before tightening the screws into the wall, make sure the screw head and shank size are suitable by inserting the screw through one of the keyhole-shaped apertures of the Wall Mounting Plates.

Do not screw the screws in all the way—leave about 2 mm to allow room for sliding the wall mount panel between the wall and the screws.

**STEP 3**—Once the screws are fixed to the wall, insert the four screw heads through the wide parts of the keyhole-shaped apertures, and then slide the EDS-510E downwards, as indicated in the figure at the right. Tighten the four screws for more stability.

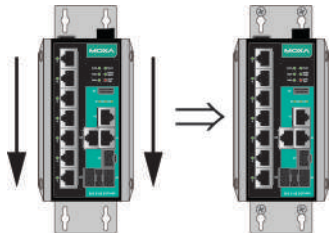

## Wiring Requirements



### WARNING

Do not disconnect modules or wires unless power has been switched off or the area is known to be non-hazardous. The devices may only be connected to the supply voltage shown on the type plate. The devices are designed for operation with a Safety Extra-Low Voltage. Thus, they may only be connected to the supply voltage connections and to the signal contact with the Safety Extra-Low Voltages (SELV) in compliance with IEC950/EN60950/ VDE0805.



## ATTENTION

This unit is a built-in type. When the unit is installed in another piece of equipment, the equipment enclosing the unit must comply with fire enclosure regulation IEC 60950/EN60950 (or similar regulation).



## ATTENTION

### **Safety First!**

Be sure to disconnect the power cord before installing and/or wiring your Moxa EtherDevice Switch.

Calculate the maximum possible current in each power wire and common wire. Observe all electrical codes dictating the maximum current allowable for each wire size.

If the current goes above the maximum ratings, the wiring could overheat, causing serious damage to your equipment.

Please read and follow these guidelines:

- Use separate paths to route wiring for power and devices. If power wiring and device wiring paths must cross, make sure the wires are perpendicular at the intersection point.  
NOTE: Do not run signal or communications wiring and power wiring through the same wire conduit. To avoid interference, wires with different signal characteristics should be routed separately
- You can use the type of signal transmitted through a wire to determine which wires should be kept separate. The rule of thumb is that wiring that shares similar electrical characteristics can be bundled together
- You should separate input wiring from output wiring
- We advise that you label the wiring to all devices in the system.

## Grounding the Moxa EDS-510E

Grounding and wire routing help limit the effects of noise due to electromagnetic interference (EMI). Run the ground connection from the ground screw to the grounding surface prior to connecting devices.



## ATTENTION

This product is intended to be mounted to a well-grounded mounting surface such as a metal panel.

## Wiring the Relay Contact

The EDS-510E has one set of relay output. This relay contact uses two contacts of the terminal block on the EDS-510E's top panel. Refer to the next section for detailed instructions on how to connect the wires to the terminal block connector, and how to attach the terminal block connector to the terminal block receptor. In this section, we illustrate the use of two contacts used to connect the relay.

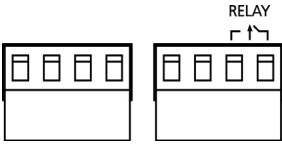

**FAULT:**

The two contacts of the 6-pin terminal block connector are used to detect user-configured events. The two wires attached to the fault contacts form an open circuit when a user-configured event is triggered. If a user-configured event does not occur, the fault circuit remains closed.

## Wiring the Redundant Power Inputs

The EDS-510E has two sets of power inputs—power input 1 and power input 2. The top and front views of one of the terminal block connectors are shown here.

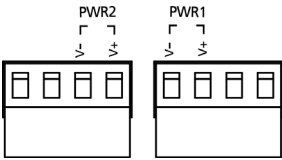

**STEP 1:** Insert the negative/positive DC wires into the V-/V+ terminals, respectively.

**STEP 2:** To keep the DC wires from pulling loose, use a small flat-blade screwdriver to tighten the wire-clamp screws on the front of the terminal block connector.

**STEP 3:** Insert the plastic terminal block connector prongs into the terminal block receptor, which is located on the EDS-510E’s top panel.

## Wiring the Digital Inputs

The EDS-510E has one set of digital input (DI). The DI consists of two contacts of the 4-pin terminal block connector on the EDS-510E’s top panel, which are used for the two DC inputs. The top and front views of one of the terminal block connectors are shown here.

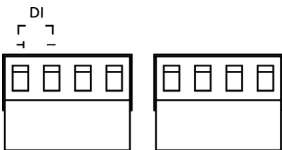

**STEP 1:** Insert the negative (ground)/positive DI wires into the  $\pm$ /I terminals, respectively.

**STEP 2:** To keep the DI wires from pulling loose, use a small flat-blade screwdriver to tighten the wire-clamp screws on the front of the terminal block connector.

**STEP 3:** Insert the plastic terminal block connector prongs into the terminal block receptor, which is located on the EDS-510E’s top panel.

## Communication Connections

Each EDS-510E switch has 4 types of communication ports:

- 1 USB console port (type B connector)
- 1 USB storage port (type A connector)
- 7 10/100BaseTX Ethernet ports
- 3 Gigabit Ethernet ports:
  - 3 10/100/1000BaseTX and 3 100/1000BaseSFP ports



## USB Console Connection

The EDS-510E has one USB console port (type B connector), located on the top panel. Use the USB cable (provided in the product package) to connect the EDS-510E's console port to your PC's USB port and install the USB driver (available in the software CD) on the PC. You may then use a console terminal program, such as Moxa PComm Terminal Emulator, to access the EDS-510E's console configuration utility.

### USB Console Port (Type B Connector) Pinouts

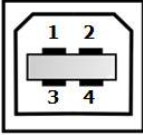

| Pin | Description  |
|-----|--------------|
| 1   | D- (Data -)  |
| 2   | VCC (+5V)    |
| 3   | D+ (Data+)   |
| 4   | GND (Ground) |

## USB Storage Connection

The EDS-510E has one USB storage port (type A connector) on the front panel. Use Moxa ABC-02-USB-T automatic backup configurator to connect the EDS-510E's USB storage port for configuration backup, firmware upgrade or system log file backup.

### ABC-02-USB Installation

Plug the ABC-02-USB into the USB storage port of the Moxa EDS-510E. Securing the ABC-02-USB on the wall with an M4 screw is suggested.

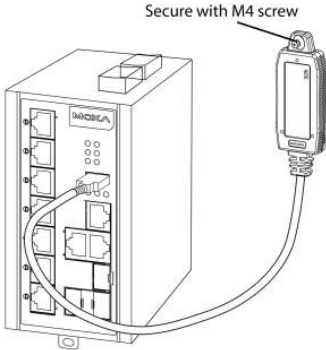

### USB Storage Port (Type A Connector) Pinouts

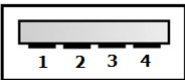

| Pin | Description  |
|-----|--------------|
| 1   | VCC (+5V)    |
| 2   | D- (Data -)  |
| 3   | D+ (Data+)   |
| 4   | GND (Ground) |

## 10/100BaseT(X) Ethernet Port Connection

The 10/100BaseT(X) ports located on the EDS-510E's front panel are used to connect to Ethernet-enabled devices. Most users configure these ports for Auto MDI/MDI-X mode, in which case the port's pinouts are adjusted automatically depending on the type of Ethernet cable used

(straight-through or cross-over), and the type of device (NIC-type or HUB/Switch-type) connected to the port.

In what follows, we give pinouts for both MDI (NIC-type) ports and MDI-X (HUB/Switch-type) ports. We also give cable wiring diagrams for straight-through and cross-over Ethernet cables.

### RJ45 (8-pin, MDI) Port Pinouts

| Pin | Signal |
|-----|--------|
| 1   | Tx+    |
| 2   | Tx-    |
| 3   | Rx+    |
| 6   | Rx-    |

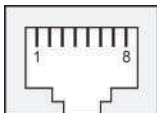

### RJ45 (8-pin, MDI-X) Port Pinouts

| Pin | Signal |
|-----|--------|
| 1   | Rx+    |
| 2   | Rx-    |
| 3   | Tx+    |
| 6   | Tx-    |

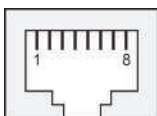

### RJ45 (8-pin) to RJ45 (8-pin) Straight-through Cable Wiring

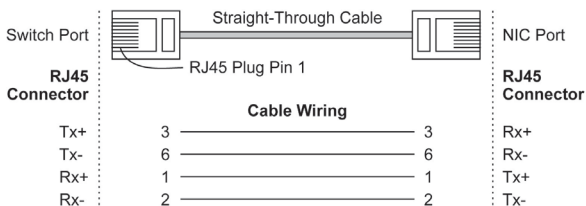

### RJ45 (8-pin) to RJ45 (8-pin) Cross-over Cable Wiring

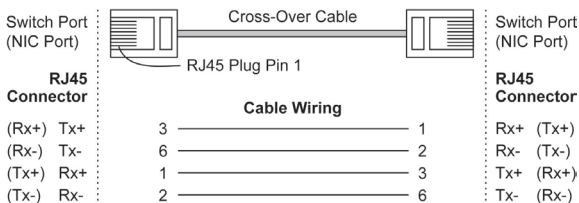

## 1000BaseT Ethernet Port Connection

1000BaseT data is transmitted on differential TRD+/- signal pairs over copper wires.

### MDI/MDI-X Port Pinouts

| Pin | Signal  |
|-----|---------|
| 1   | TRD(0)+ |
| 2   | TRD(0)- |
| 3   | TRD(1)+ |
| 4   | TRD(2)+ |
| 5   | TRD(2)- |
| 6   | TRD(1)- |
| 7   | TRD(3)+ |
| 8   | TRD(3)- |

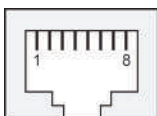

## 100/1000BaseSFP (mini-GBIC) Fiber Port

The gigabit Ethernet ports on the EDS-510E are 100/1000BaseSFP Fiber ports, which require using the 100M or 1G mini-GBIC fiber transceivers to work properly. Moxa provides completed transceiver models for different distance requirement.

The concept behind the LC port and cable is quite straightforward. Suppose that you are connecting devices I and II; contrary to electrical signals, optical signals do not require a circuit in order to transmit data. Consequently, one of the optical lines is used to transmit data from device I to device II, and the other optical line is used transmit data from device II to device I, for full-duplex transmission.

Remember to connect the Tx (transmit) port of device I to the Rx (receive) port of device II, and the Rx (receive) port of device I to the Tx (transmit) port of device II. If you make your own cable, we suggest labeling the two sides of the same line with the same letter (A-to-A and B-to-B, as shown below, or A1-to-A2 and B1-to-B2).

### LC-Port Pinouts

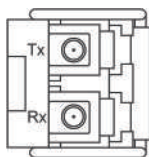

### LC-Port to LC-Port Cable Wiring

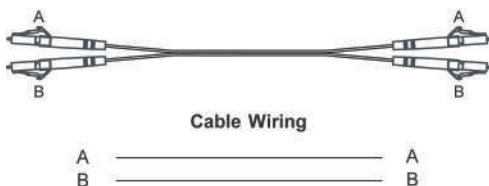

### ATTENTION

This is a Class 1 Laser/LED product. To avoid causing serious damage to your eyes, do not stare directly into the Laser Beam.

## Reset Button

There are two functions available on the reset button. One is to reset the Ethernet switch to factory default settings by pressing and holding the reset button for 5 seconds. Use a pointed object, such as a straightened paper clip or toothpick, to depress the reset button. This will cause the STATE LED to blink once a second. After depressing the button for 5 continuous seconds, the STATE LED will start to blink rapidly. This indicates that factory default settings have been loaded and you can release the reset button.

When the ABC-02-USB is connected to the EDS-510E Ethernet switch, the reset button allows quick configuration and backs up log files to the ABC-02-USB. Press the Reset button on top of the EDS-510E, the Ethernet switch will start backing up current system configuration files and event logs to the ABC-02-USB.

**NOTE** Do NOT power off the Ethernet switch when loading default settings.

## Turbo Ring DIP Switch Settings

EDS-510E series are plug-and-play managed redundant Ethernet switches. The proprietary Turbo Ring protocol was developed by Moxa to provide better network reliability and faster recovery time. Moxa Turbo Ring's recovery time is less than 300 ms (**Turbo Ring**) or 20 ms (**Turbo Ring V2**) —compared to a 3- to 5-minute recovery time for commercial switches—decreasing the possible loss caused by network failures in an industrial setting.

There are 4 Hardware DIP Switches for Turbo Ring on the top panel of EDS-510E that can help setup the Turbo Ring easily within seconds. If you do not want to use a hardware DIP switch to setup the Turbo Ring, you can use a web browser, telnet, or console to disable this function.

**NOTE** Please refer to the **Turbo Ring** section in **Communication Redundancy** User's Manual for more detail information about the setting and usage of **Turbo Ring** and **Turbo Ring V2**.

### EDS-510E Series DIP Switches

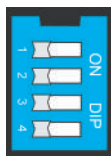

The default setting for each DIP Switch is OFF. The following table explains the effect of setting the DIP Switch to the ON position.

#### "Turbo Ring" DIP Switch Settings

| DIP 1                    | DIP 2  | DIP 3  | DIP 4  |
|--------------------------|--|--|--|
| Reserved for future use. | <u>ON</u> : Enables this EDS as the Ring Master.   | <u>ON</u> : Enables the default "Ring Coupling" ports. | <u>ON</u> : Activates DIP switch 2 and 3 to configure "Turbo Ring" settings. |
|                          | <u>OFF</u> : This EDS will not be the Ring Master. | <u>OFF</u> : Do not use this EDS as the ring coupler.  | <u>OFF</u> : DIP switch 1, 2, and 3 will be disabled.                        |

#### "Turbo Ring V2" DIP Switch Settings

| DIP 1   | DIP 2  | DIP 3   | DIP 4   |
|---|--|---|---|
| <u>ON</u> : Enables the default "Ring Coupling (backup)" port when DIP switch 3 is already enabled.   | <u>ON</u> : Enables this EDS as the Ring Master.   | <u>ON</u> : Enables the default "Ring Coupling" port. | <u>ON</u> : Activates DIP switch 1, 2, and 3 to configure "Turbo Ring V2" settings. |
| <u>OFF</u> : Enables the default "Ring Coupling (primary)" port when DIP switch 3 is already enabled. | <u>OFF</u> : This EDS will not be the Ring Master. | <u>OFF</u> : Do not use this EDS as a ring coupler.   | <u>OFF</u> : DIP switch 1, 2, and 3 will be disabled.                               |

**NOTE** You must enable the Turbo Ring function first before using the DIP switch to activate the Master and Coupler functions.

**NOTE** If you do not enable any of the EDS-510E switches to be the Ring Master, the Turbo Ring protocol will automatically choose the EDS-510E with the smallest MAC address range to be the Ring Master. If you accidentally enable more than one EDS-510E to be the Ring Master, these EDS-510E switches will auto-negotiate to determine which one will be the Ring Master.

## LED Indicators

The front panel of the Moxa EDS-510E contains several LED indicators. The function of each LED is described in the following table:

| LED       | Color | Status   | Description  |
|-----------|-------|----------|--|
| STATE     | Green | On       | The system passed the self-diagnosis test on boot-up and is ready to run.  |
|           |       | Blinking | <ol style="list-style-type: none"> <li>The switch is under reset progress (1 time/s).</li> <li>Detect ABC-02-USB connect to the switch (1 time/2s).</li> </ol>   |
|           | Red   | On       | <p>The system failed self-diagnosis on boot-up.</p> <ul style="list-style-type: none"> <li>RAM Test Fail / System Info. Read Fail / Switch Initial Fail / PTP PHY Error. (+ Green MSTR lit on : HW FAIL)</li> <li>FW Checksum Fail / Uncompress Fail. (+ Green Coupler lit on: SW FAIL)</li> </ul>                                   |
| FAULT     | Red   | On       | <ol style="list-style-type: none"> <li>The signal contact is open.</li> <li>ABC Loading/Saving Fail.</li> <li>The port being disabled because of the ingress multicast and broadcast packets exceed the ingress rate limit.</li> <li>Incorrect loop connection in a single switch.</li> <li>Invalid Ring port connection.</li> </ol> |
| PWR1      | Amber | On       | Power is being supplied to the main module's power input PWR1.   |
|           |       | Off      | Power is not being supplied to the main module's power input PWR1.   |
| PWR2      | Amber | On       | Power is being supplied to the main module's power input PWR2.   |
|           |       | Off      | Power is not being supplied to the main module's power input PWR2.   |
| MSTR/HEAD | Green | On       | <ol style="list-style-type: none"> <li>The switch is set as the Master of the Turbo Ring, or as the Head of the Turbo Chain.</li> <li>POST H.W. Fail (+Stat on and Fault blinking).</li> </ol>   |

| LED  | Color | Status                       | Description  |
|--|-------|------------------------------|--|
|  |       | Blinking                     | <ol style="list-style-type: none"> <li>The switch has become the Ring Master of the Turbo Ring.</li> <li>The Head of the Turbo Chain, after the Turbo Ring or the Turbo Chain is down.</li> <li>The switch is set as Turbo Chain's Member and the corresponding chain port is down.</li> </ol> |
|  |       | Off                          | <ol style="list-style-type: none"> <li>The switch is not the Master of this Turbo Ring.</li> <li>This switch is set as a Member of the Turbo Chain.</li> </ol>   |
| <b>CPLR/ TAIL</b>                            | Green | On                           | <ol style="list-style-type: none"> <li>The switch's coupling function is enabled to form a back-up path.</li> <li>When it's set as the Tail of the Turbo Chain.</li> <li>POST S.W. Fail (+Stat on and Fault blinking)</li> </ol>   |
|  |       | Blinking                     | <ol style="list-style-type: none"> <li>Turbo Chain is down.</li> <li>The switch is set as Turbo Chain's Member and the corresponding chain port is down.</li> </ol>  |
|  |       | Off                          | <ol style="list-style-type: none"> <li>This switch has disabled the coupling function.</li> <li>This switch is set as a Member of the Turbo Chain.</li> </ol>  |
| <b>FAULT + MSTR/HEAD + CPLR/TAIL</b>         |       | Rotate Blinking Sequentially | ABC-02-USB is importing/exporting files.   |
| <b>STATE + FAULT + MSTR/HEAD + CPLR/TAIL</b> |       | Blinking                     | Switch is being discovered/located by MXview (2 times/s).  |
| <b>10M/ 100M (TP)</b>                        | Amber | On                           | TP port's 10 or 100 Mbps link is active.   |
|  |       | Blinking                     | Data is being transmitted at 10 or 100 Mbps.   |
|  |       | Off                          | TP port's 10/100 Mbps link is inactive.  |
| <b>1000M (TP)</b>                            | Green | On                           | TP port's 1000 Mbps link is active.  |
|  |       | Blinking                     | Data is being transmitted at 1000 Mbps.  |
|  |       | Off                          | TP port's 1000 Mbps link is inactive.  |
| <b>100M (SFP)</b>                            | Amber | On                           | SFP port's 100 Mbps link is active.  |
|  |       | Blinking                     | Data is being transmitted at 100 Mbps.   |
|  |       | Off                          | SFP port's 100 Mbps link is inactive.  |
| <b>1000M (SFP)</b>                           | Green | On                           | SFP port's 1000 Mbps link is active.   |
|  |       | Blinking                     | Data is being transmitted at 1000 Mbps.  |
|  |       | Off                          | SFP port's 1000 Mbps link is inactive.   |

## Specifications

| <b>Technology</b>               |   |
|---------------------------------|---|
| Standards                       | IEEE 802.3 for 10BaseT<br>IEEE 802.3u for 100BaseT(X) and 100BaseFX<br>IEEE 802.3ab for 1000BaseT(X)<br>IEEE 802.3z for 1000BaseX   |
| Protocols                       | IGMPv1/v2/v3, GMRP, GVRP, SNMPv1/v2c/v3, DHCP Server/Client, DHCP Option 66/67/82, BootP, TFTP, SNTP, SMTP, RARP, RMON, HTTP, HTTPS, Telnet, SSH, Syslog, EtherNet/IP, PROFINET, Modbus/TCP, SNMP Inform, LLDP, IEEE 1588 PTP V2, IPv6, NTP Server/Client |
| MIB                             | MIB-II, Ethernet-Like MIB, P-BRIDGE MIB, Q-BRIDGE MIB, Bridge MIB, RSTP MIB, RMON MIB Group 1, 2, 3, 9  |
| Flow Control                    | IEEE 802.3x flow control, back pressure flow control  |
| <b>Interface</b>                |   |
| RJ45 Ports                      | 7-port 10/100BaseT(X), 3-port 10/100/1000BaseT(X) auto negotiation speed  |
| Fiber Ports                     | 3-port 100/1000BaseSFP slot   |
| USB Ports                       | USB console port (type B connector)<br>USB storage port (type A connector)  |
| Button                          | Reset button  |
| LED Indicators                  | PWR1, PWR2, FAULT, STATE, 10/100M (TP port), 100/1000M (Gigabit port), MSTR/HEAD, CPLR/TAIL   |
| Alarm Contact                   | 1 relay output with current carrying capacity of 1 A @ 24 VDC   |
| Digital Input                   | 1 input with the same ground, but electrically isolated from the electronics.<br>+13 to +30V for state "1"<br>-30 to +3V for state "0"<br>Max. input current: 8 mA  |
| <b>Power</b>                    |   |
| Input Voltage                   | 12/24/48/-48 VDC, redundant dual inputs   |
| Input Current                   | 0.68 A @ 24 V   |
| Connection                      | 2 removable 4-contact terminal blocks   |
| Overload Current Protection     | Present   |
| Reverse Polarity Protection     | Present   |
| <b>Physical Characteristics</b> |   |
| Housing                         | Metal, IP30 protection  |
| Dimension                       | 79.8 x 135 x 116 mm (3.13 x 5.31 x 4.57 in)   |
| Installation                    | DIN-rail mounting, wall mounting (with optional kit)  |
| <b>Environmental Limits</b>     |   |
| Operating Temperature           | -10 to 60°C (14 to 140°F) for standard models<br>-40 to 75°C (-40 to 167°F) for T models  |
| Storage Temperature             | -40 to 85°C (-40 to 185°F)  |
| Ambient Relative Humidity       | 5 to 95% (non-condensing)   |
| Altitude                        | Up to 2000m<br>Note: Please contact Moxa if you require products  |

|                             |  |
|-----------------------------|--|
|                             | guaranteed to function properly at higher altitudes.   |
| <b>Regulatory Approvals</b> |  |
| Safety                      | UL 508   |
| EMI                         | FCC Part 15 Subpart B Class A  |
| EMS                         | EN 61000-4-2 (ESD) Level 4, EN 61000-4-3 (RS) Level 3,<br>EN 61000-4-4 (EFT) Level 4, EN 61000-4-5 (Surge) Level 4,<br>EN 61000-4-6 (CS) Level 3, EN 61000-4-8 |
| Shock                       | IEC 60068-2-27   |
| Free Fall                   | IEC 60068-2-32   |
| Vibration                   | IEC 60068-2-6  |
| <b>Warranty</b>             |  |
| Warranty                    | 5 years  |

**Technical Support Contact Information**  
**[www.moxa.com/support](http://www.moxa.com/support)**

Moxa Americas:

Toll-free: 1-888-669-2872

Tel: 1-714-528-6777

Fax: 1-714-528-6778

Moxa China (Shanghai office):

Toll-free: 800-820-5036

Tel: +86-21-5258-9955

Fax: +86-21-5258-5505

Moxa Europe:

Tel: +49-89-3 70 03 99-0

Fax: +49-89-3 70 03 99-99

Moxa Asia-Pacific:

Tel: +886-2-8919-1230

Fax: +886-2-8919-1231