



UC-7101-LX Quick Installation Guide

Second Edition, June 2008

1. Overview

The UC-7101 Series of mini size RISC-based ready-to-run embedded computers feature one 10/100 Mbps Ethernet port and one RS-232/422/485 serial port in a built-in μ CLinux ARM9 box. In addition, the UC-7101 provides an internal SD socket for storage expansion, offers high performance communication and unlimited storage in a super compact, palm-size box. The UC-7101 is the right high-performance solution for embedded applications that use a lot of memory, but that are housed in a small physical space.

2. Package Checklist

Before installing the UC-7101, verify that the package contains the following items:

- 1 UC-7101
- Document and Software CD
- UC-7101 Quick Installation Guide
- Cross-over Ethernet cable: RJ45 to RJ45, 100 cm
- Console port cable: CBL-4PINDB9F-100 4-pin header to DB9 (female) cable, 100 cm
- Universal Power Adaptor
- Product Warranty Statement

Optional Accessories

- DK-35A DIN-Rail Mounting Kit (35 mm)

Note: Please notify your sales representative if any of the above items are missing or damaged.

3. UC-7101 Panel Layout

The UC-7101 comes with one software selectable RS-232/422/485 serial port, one RS-232 console port, one 10/100 Mbps LAN port, and one internal SD slot. The following figures show the panel layouts of the UC-7101.

UC-7101 Appearance

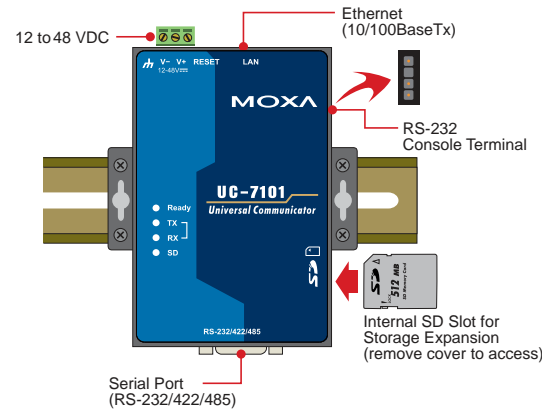

UC-7101 Dimensions

The dimensions of the three UC-7101 models are shown in the following figure.

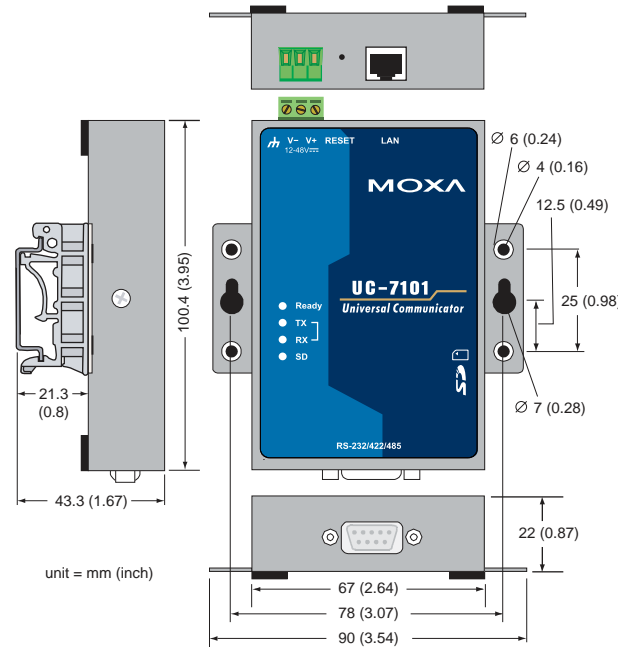

LED Indicators

The following LED indicators are located on the UC-7101's top panel.

LED Name	LED Color	LED Function
Ready	Green	Power is on and functioning normally
	Off	Power is off or power error exists
SD	Green	SD card is detected
	Off	No SD card is detected
TxD	Green	Serial port is transmitting data
	Off	Serial port is not transmitting data
RxD	Yellow	Serial port is receiving data
	Off	Serial port is not receiving data

4. Installing the UC-7101

Wall or Cabinet Mounting

The UC-7101 has built-in "ears" for attaching the embedded computer to a wall or the inside of a cabinet. We suggest using two screws per ear to attach the UC-7101 to a wall or cabinet. The heads of the screws should be less than 6.0 mm in diameter, and the shafts should be less than 3.5 mm in diameter, as shown in the figure at the right.

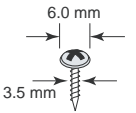

DIN-Rail Mounting

DIN-rail attachments can be purchased separately to attach the product to a DIN-rail.

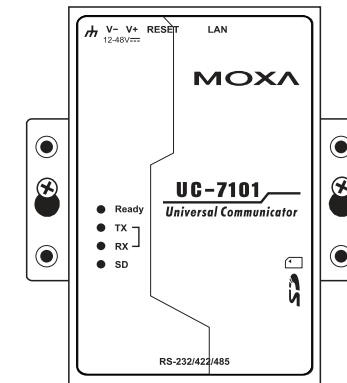

P/N: 1802071010011

5. Connector Description

Power Connector

Connect the 12 to 48 VDC LPS or Class 2 power line to the UC-7101's terminal block. If the power is properly supplied, the Power LED will light up. The OS is ready when the Ready LED glows a solid green. The power for this product is intended to be supplied by a Listed Power Unit, and rated to deliver 12 to 48 VDC at a minimum of 300 mA.

Grounding the UC-7101

Grounding and wire routing help limit the effects of noise due to electromagnetic interference (EMI). Run the ground connection from the ground screw to the grounding surface prior to connecting the power.

ATTENTION

This product is intended to be mounted to a well-grounded mounting surface, such as a metal panel.

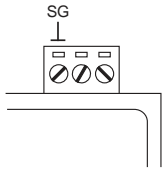

SG: The Shielded Ground (sometimes called Protected Ground) contact is the left most contact of the 3-pin power terminal block connector when viewed from the angle shown here. Connect the SG wire to an appropriate grounded metal surface.

Ethernet Port

The 10/100 Mbps Ethernet port requires using RJ45 connectors.

PIN	Signal
1	ETx+
2	ETx-
3	ERx+
6	ERx-

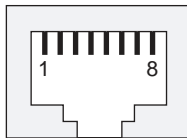

Serial Port

The UC-7101's serial port uses a DB9 connector. Each port can be configured by software for RS-232, RS-422, or RS-485. The pin assignments for the port are shown in the following table:

Male DB9 (UC-7101)

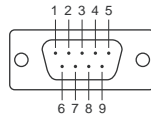

Pin	RS-232	RS-422	RS-485 (4-wire)	RS-485 (2-wire)
1	DCD	TxDA(-)	TxDA(-)	---
2	RxD	TxDB(+)	TxDB(+)	---
3	TxD	RxDB(+)	RxDB(+)	DataB(+)
4	DTR	RxDA(-)	RxDA(-)	DataA(-)
5	GND	GND	GND	GND
6	DSR	---	---	---
7	RTS	---	---	---
8	CTS	---	---	---

SD Slot

The UC-7101 has an internal SD slot for storage expansion. To install an SD card, first use a screw driver to remove the SD slot cover to access the slot. The slot is located on the right panel of the UC-7101. Plug the SD card directly into the socket. When an SD card is inserted, the system will mount the SD to /mnt/sd. To remove the SD card from the slot, press the SD card in slightly with your finger, and then remove your finger to cause the card to spring out partially. You may now grasp the top of the card with two fingers and pull it out.

Console Port

The serial console port is a 4-pin pin-header RS-232 port. It is used for the serial console terminal, which is useful for viewing boot-up messages. Use the CBL-4PINDB9F-100 cable included with the UC-7101 to connect a PC to the UC-7101's serial console port.

Pin	Signal
4	GND
3	NC*
2	RxD
1	TxD

*NC=Not Connected



Reset

Press the "Reset" button and hold it in for at least 5 seconds to load the factory default configuration. After the factory default configuration has been loaded, the system will reboot automatically. The Ready LED will blink on and off for the first 5 seconds, and then maintain a steady glow once the system has rebooted.

6. Powering on the UC-7101

To power on the UC-7101, connect the "terminal block to power jack converter" to the UC-7101's DC terminal block (located on the left side of the top panel), and then connect the power adaptor. Note that the Shielded Ground wire should be connected to the right most pin of the terminal block. Once the system is ready, the Ready LED will light up.

7. Connecting the UC-7101 to a PC

There are two ways to connect the UC-7101 to a PC: (1) through the serial console port, or (2) by Telnet over the network. The COM settings for the serial console port are: **Baudrate=115200 bps, Parity=None, Data bits=8, Stop bits =1, Flow Control=None.**

ATTENTION

Use the CBL-4PINDB9F-100 cable included with the product to connect a PC to the UC-7101's serial console port. Remember to choose "VT100" terminal type.

To connect by Telnet, you need to know the UC-7101's IP address and netmask. The default LAN settings are shown below. For first-time configuration, you may find it convenient to use a cross-over Ethernet cable to connect directly from the PC to the UC-7101.

	Default IP Address	Netmask
LAN	192.168.3.127	255.255.255.0

Once the UC-7101 is powered on, the Ready LED will light up. Use the following default login name and password to proceed. The defaults are:

Login: root

Password: root

8. Configuring the Ethernet Interface

Please refer to the UC-7101 User's Manual for information on how to configure the Ethernet interface.

CAUTION

RISK OF EXPLOSION IF BATTERY IS REPLACED BY AN INCORRECT TYPE. DISPOSE OF USED BATTERIES ACCORDING TO THE INSTRUCTION.

MOXA®

Click here for online support:
www.moxa.com/support

The Americas: +1-714-528-6777 (toll-free: 1-888-669-2872)
Europe: +49-89-3 70 03 99-0
Asia-Pacific: +886-2-8919-1230
China: +86-21-5258-9955 (toll-free: 800-820-5036)

© 2008 Moxa Inc., all rights reserved.
Reproduction without permission is prohibited.