

ICF-1280I Series Quick Installation Guide

Moxa Industrial PROFIBUS-to-Fiber Converter

Edition 5.0, February 2017

Technical Support Contact Information www.moxa.com/support

Moxa Americas:

Toll-free: 1-888-669-2872

Tel: 1-714-528-6777

Fax: 1-714-528-6778

Moxa China (Shanghai office):

Toll-free: 800-820-5036

Tel: +86-21-5258-9955

Fax: +86-21-5258-5505

Moxa Europe:

Tel: +49-89-3 70 03 99-0

Fax: +49-89-3 70 03 99-99

Moxa Asia-Pacific:

Tel: +886-2-8919-1230

Fax: +886-2-8919-1231

Moxa India:

Tel: +91-80-4172-9088

Fax: +91-80-4132-1045



© 2017 Moxa Inc. All rights reserved.

Fl.4, No. 135, Lane 235, Baoqiao Rd., Xindian Dist., New Taipei City,
Taiwan, R.O.C

P/N: 1802012800016



Introduction

The ICF-1280I series PROFIBUS-to-fiber converters are based on the PROFIBUS DP standard, and are compliant with EN 50170. The converters are mainly used to extend the transmission distance of PROFIBUS devices over optical fiber, and provide redundant transmission. More specifically the ICF-1280I series converts PROFIBUS signals between copper and fiber wires, and extends PROFIBUS transmission up to 4 km (for multi-mode models) or up to 45 km (for single-mode models). In addition, the ICF-1280I series converters have dual fiber ports that can be used to form a ring topology for redundant transmission, and avoid packet loss when a fiber path is broken. The ICF-1280I converters also provide 2 kV isolation protection for the PROFIBUS system and dual power inputs to ensure uninterrupted operation.

The ICF-1280I series converters are uniquely designed with Remote Fiber Diagnosis, which uses DIP switches to eliminate the need for fiber optic sensors. Remote Fiber Diagnosis can detect fiber connections for the overall topology from any individual converter, and determine which side (Tx or Rx) is causing the problem for the converter.

Why Convert PROFIBUS to Fiber?

Optical fiber communication not only extends the communication distance, but also provides the following advantages:

- **Immunity to electrostatic interference:** Fiber is immune to electromagnetic interference and radio frequency interference. It provides a clean communication path and is immune to cross-talk.
- **Insulation:** Optical fiber is an insulator interface; the glass fiber eliminates the need for using electric currents as the communication medium.
- **Security:** Fiber cannot be tapped by conventional electric means and is very difficult to tap into optically, whereas radio and satellite communication signals can be captured easily for decoding.
- **High reliability and low maintenance:** Fiber cable is immune to adverse temperature and moisture conditions. As a result, it does not corrode or lose its capacity to transmit signals, and is not affected by short circuits, power surges, or static electricity.

Auto/Manual Baudrate Settings

The ICF-1280I series converters convert the signal back and forth between PROFIBUS and fiber at baudrates from 9.6 kbps to 12 Mbps. Engineers do not need to know the baudrate of the connected PROFIBUS device; the ICF-1280I series converters can automatically detect the baudrate of the PROFIBUS device and apply this baudrate directly. This is an extremely convenient feature. If necessary, baudrates can be set to a fixed value via DIP switches to shorten the baudrate detection period when the system initializes.

PROFIBUS Fail Safe

Electrical noise may be generated when a PROFIBUS device malfunctions or the serial interface fails, resulting in bus failure. Traditional media converters transmit noise signals through the fiber wire to the other converter. This not only disrupts data communication between the two buses, but will also bring communication across the entire system to a

halt. When this occurs, engineers will not be able to easily locate the failed device because the entire PROFIBUS network is down. To avoid this situation, the ICF-1280I series converter has a mechanism to detect and recognize noise signals. If the bus fails on one side, the noise signal will not propagate through the ICF-1280I converter and affect additional bus segments. In addition, the ICF-1280I converter will also trigger an alarm to provide the location of the failure to the field engineer.

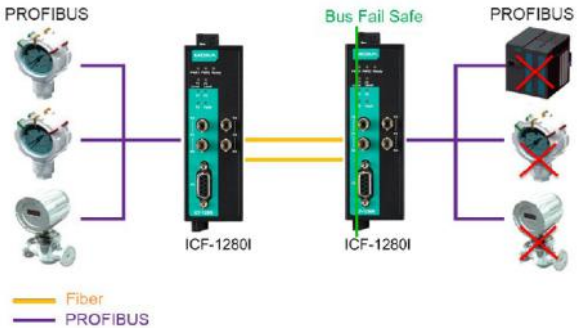

Fiber Link Monitoring

The ICF-1280I series converter provides a fiber link monitoring function to detect the communication errors on both sides of the fiber connection. When a communication error occurs, a red LED status indicator (P1, P2, or Fault LED) will turn on and the relay alarm will activate. If a fiber abnormality occurs on a remote fiber segment, the Fault LED will flash. Engineers can then use the Fiber Diagnosis function for troubleshooting.

Reverse Power Protection

The Reverse Power Protection feature protects against accidentally connecting the power cables to the wrong terminal. The converter is designed to detect automatically which power wire is positive and which is negative, and then adjust the power supply accordingly.

Remote Fiber Diagnosis

Optical fiber cables are often deployed for long distance communication and a fiber optic inspection pen is used by engineers to ensure proper communication quality of the fiber cable. The ICF-1280I series converters eliminate the need for a fiber optic inspection pen by providing a Remote Fiber Diagnosis function that uses DIP switch adjustments. There are two major functions provided by Remote Fiber Diagnosis: (1) determining which side (Tx or Rx) is causing the problem on the converter; (2) examining the fiber connections for the overall topology from any individual converter. Fiber cable abnormalities can be automatically detected and identified by the LED indicator even if it is not adjacent to the converter. Remote Fiber Diagnosis facilitates fiber cable deployment and management, and also significantly shortens troubleshooting time by examining fiber connections for the overall topology from any individual converter.

Using Remote Fiber Diagnosis:

Set DIP switch SW8 to the ON position on any ICF-1280I converter and then note the status of the **Ready** LED. A flashing green **Ready** LED indicates that the Fiber Diagnosis has finished. The **Fault** LED indicates the location of the fiber connection abnormality. The **P1** or **P2** LED indicates which side (Tx or Rx) is causing the problem.

The **Fault** LED will shine a steady red to indicate an adjacent fiber connection error, or flash red to indicate a non-adjacent fiber connection error. If there are no fiber connection errors in the entire topology, the related LEDs will shine green or remain OFF. If the fiber connection error is adjacent to the converter, the status will also be indicated by the **P1** (Port 1) or **P2** (Port 2) LEDs. A flashing red light on **P1** (or **P2**) means that the Rx fiber cable connected to this port is broken. Similarly, a solid red light on **P1** (or **P2**) means that the Tx fiber cable for this port is broken. If the fiber connection error is not adjacent to the converter (i.e., the fiber cables connected to this converter are working properly), the **Fault** LED will flash red. As a result, you should run Remote Fiber Diagnosis on every other (second) converter in the topology to recursively troubleshoot the problem. Further descriptions and troubleshooting can be found in the **Troubleshooting** table.

Redundant Ring

The ICF-1280I series converters can connect PROFIBUS devices in a redundant ring topology. Use the DIP switch to configure all the ICF-1280I converters to **Redundant Ring** mode. When a PROFIBUS master transmits a signal from one converter to the PROFIBUS slave devices, this signal will travel to all the converters around the ring until it returns to the original converter and terminate.

How to form a redundant ring topology:

To form a redundant ring topology, connect the **Tx Port (Port 1)** on the first ICF-1280I converter to the **Rx Port (Port 2)** on the following converter. Then, connect the **Tx Port (Port 2)** on the first ICF-1280I converter to the **Rx Port (Port 1)** on the preceding converter. Similarly, connect the **Rx Port (Port 1)** on the first ICF-1280I converter to the **Tx Port (Port 2)** on the following converter. Then, connect the **Rx Port (Port 2)** on the first ICF-1280I converter to the **Tx Port (Port 1)** of the preceding converter.

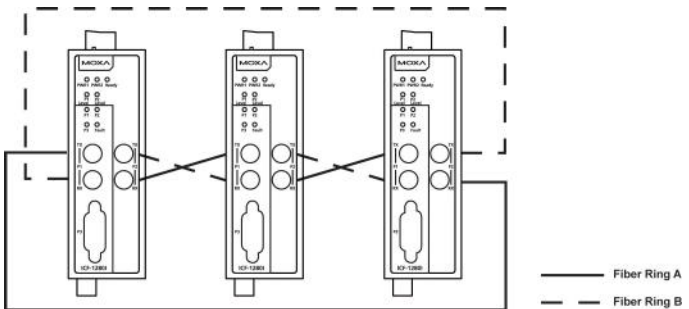

Features

- Redundant Ring mode for fiber communication backup with zero recovery time

- Remote Fiber Diagnosis
- Auto baudrate detection and data speeds up to 12 Mbps
- PROFIBUS bus fail safe
- Alarm by relay output
- Provides 2 kV galvanic isolation
- Power polarity protection
- Extend PROFIBUS transmission distance:
 - Up to 45 km with single-mode (ICF-1280I-S models)
 - Up to 4 km with multi-mode (ICF-1280I-M models)
- Point-to-point, linear (bus), star, and redundant ring topologies
- Dual power input for redundancy
- Wide operating temperature from -40 to 75°C (for “-T” models)
- Supports Fiber Signal Intensity Diagnosis

Package Checklist

Before installing the ICF-1280I converter, verify that the package contains the following items:

- ICF-1280I PROFIBUS-to-fiber converter
- Quick installation guide (printed)
- Warranty card

NOTE: Please notify your sales representative if any of the above items are missing or damaged.

Mounting Dimensions (Unit: mm)

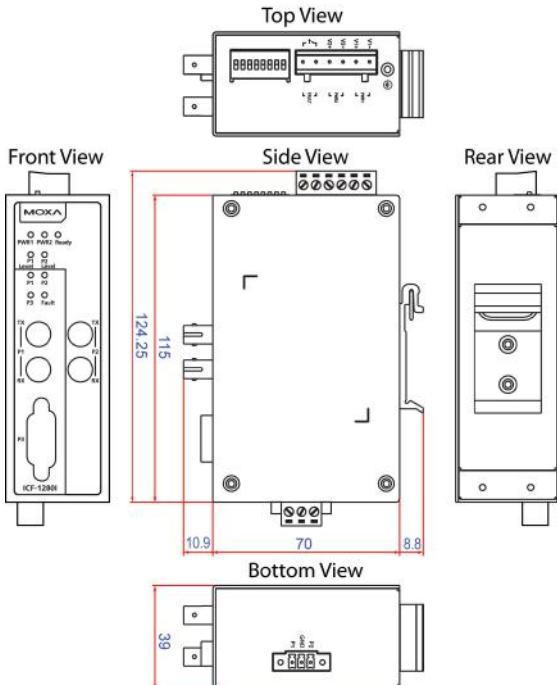

ICF-1280I Panel Layouts

Top View

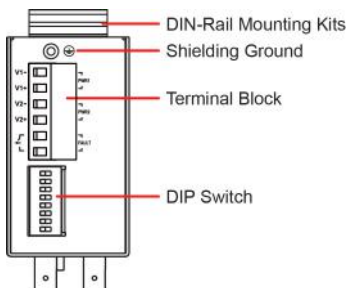

Bottom View

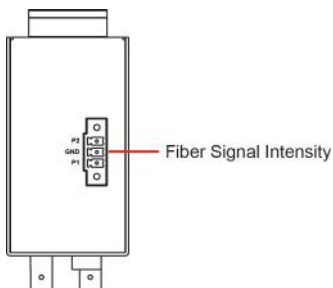

Front View

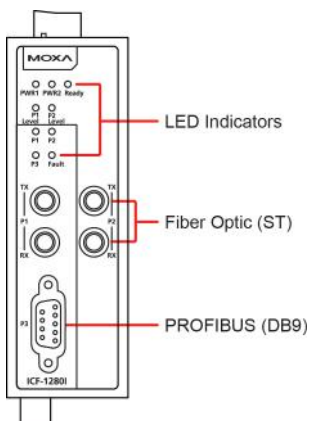

ATTENTION

Electrostatic Discharge Warning!

To protect the product from damage due to electrostatic discharge, we recommend wearing a grounding device when handling your ICF-1280I series converters.

Mounting

The aluminum DIN rail attachment plate should be fixed to the back panel of the ICF-1280I converter when you take it out of the box. If you need to reattach the DIN rail attachment plate to the ICF-1280I converter, make sure the stiff metal spring is situated towards the top, as shown in the figures below.

STEP 1:

Insert the top of the DIN rail into the slot just below the stiff metal spring.



STEP 2:

The DIN rail attachment unit will snap into place as shown below.



To remove the ICF-1280I series converter from the DIN rail, simply reverse Steps 1 and 2 above.

Wiring the Alarm Contact

The alarm contact is made up of the left two contacts of the terminal block on the ICF-1280I's top panel. Refer to the next section for detailed instructions on how to connect the wires to the terminal block connector, and how to attach the terminal block connector to the terminal block receptor.

In this section, we explain the meaning of the two contacts used to connect the alarm contact.

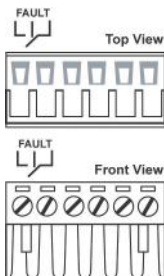

FAULT: The two middle contacts of the 6-contact terminal block connector are used to detect both power faults and port faults.

Note: Please see the LED indicator table on page 11 for details.

Wiring the Redundant Power Inputs

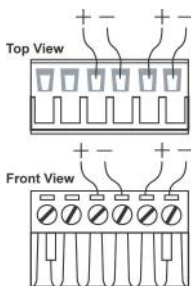

STEP 1: Insert the negative/positive DC wires into the V+/V- terminals.

STEP 2: To keep the DC wires from pulling loose, use a small flat-blade screwdriver to tighten the wire-clamp screws on the front of the terminal block connector.

STEP 3: Insert the plastic terminal block connector prongs into the terminal block receptor, which is located on the ICF-1280I's top panel.



ATTENTION

Before connecting the ICF-1280I to the DC power inputs, make sure the DC power source voltage is stable.

You should also pay attention to the following:

- The temperature rating of the input connection cable should be higher than 91°C.
- The cross sectional area of the ground wire should be at least 3.31 mm².
- The terminal block plug should be suitable for 28-12 AWG (0.0804-3.31 mm²) wire and a torque of 4.5 lb-in.

Fiber Cable

ST-Port Pinouts



ST-Port to ST-Port Cable Wiring



Cable Wiring



PROFIBUS Pin Assignment

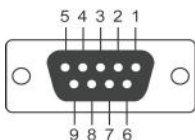

PIN	Signal Name
1	N.C.
2	N.C.
3	PROFIBUS D+
4	RTS
5	Signal common
6	5 V
7	N.C.
8	PROFIBUS D-
9	N.C.

Federal Communications Commission Statement

This device complies with part 15 of the FCC Rules. Operation is subject to the following two conditions:

1. This device may not cause harmful interference, and
2. This device must accept any interference received, including interference that may cause undesired operation.

ATEX and IECEx Information

1. Certificate number
ATEX: DEMKO 14 ATEX 1384X
IECEX: IECEX UL 14.0094X
2. Ambient range
-40°C ≤ Tamb ≤ 75°C for models with suffix of "-T"
-10°C ≤ Tamb ≤ 60°C for models without suffix of "-T"
3. Certification string:
ATEX: Ex nA nC IIC T4 Gc, Ex nA nC op is IIC T4 Gc
IECEX: Ex nA nC IIC T4 Gc
4. Standards covered
EN 60079-0:2012+A11:2013/IEC 60079-0:2011 Ed.6
EN 60079-15:2010/IEC 60079-15:2010 Ed.4



5. Conditions of safe usage:

- This equipment must be installed in an enclosure that can only be accessed with a key or other tool, and which provides a degree of protection not less than IP54 in accordance with IEC 60079-15.
- These devices are designed for use in an area of not more than pollution degree 2 in accordance with IEC 60664-1.
- Transient protection must be provided and set at a level not exceeding 140% of the peak rated voltage value at the supply terminals to the equipment.

Slot Time Settings

Although ICF-1280I series converters can be connected in different topologies with a large number of units, the total cable length and network topology can give rise to frame delays. A sufficient slot time is required to prevent the PROFIBUS master from timing out. Engineers are recommended to set the PROFIBUS master's slot time according to the following formulas.

For linear and star topologies:

$$\text{Slot time} = A + B \times L + 13 \times N$$

Transmission Speed (kbps)	A	B
12000	811	120
6000	461	60
3000	261	30
1500	161	15
500	111	5
187.5	71	1.875
93.75	71	0.9375
45.45	411	0.4545
19.2	71	0.192
9.6	71	0.096

For redundant ring topology:

$$\text{Slot time} = A + B \times L + C \times N$$

Transmission Speed (kbps)	A	B	C
12000	1651	240	28
6000	951	120	24
3000	551	60	24
1500	351	30	24
500	251	10	24
187.5	171	3.75	24
93.75	171	1.875	24
45.45	851	0.909	24
19.2	171	0.384	24
9.6	171	0.192	24

L: The length of the fiber optic cable, in kilometers.

N: The number of converters in the system.

A, B, C: Parameters set according to different baudrates.

Note: To avoid frame conflicts, we recommend setting the PROFIBUS command retry limit ≥ 3 , and the slot time < 262128 .

DIP Switch Settings

There are 8 DIP switches on the top panel of the ICF-1280I series converter. All DIP switches except SW5 are set to the factory default OFF position.

Transmission Speed (kbps)	SW1	SW2	SW3	SW4
Auto (default)	OFF	OFF	OFF	OFF
12000	OFF	OFF	OFF	ON
6000	OFF	OFF	ON	OFF
3000	OFF	OFF	ON	ON
1500	OFF	ON	OFF	OFF
500	OFF	ON	OFF	ON
187.5	OFF	ON	ON	OFF
93.75	OFF	ON	ON	ON
45.45	ON	OFF	OFF	OFF
19.2	ON	OFF	OFF	ON
9.6	ON	OFF	ON	OFF

Setting	ON	OFF
SW5	Fiber Link Monitor	Disable
SW8	Remote Fiber Diagnosis*	Disable

Topology	SW6	SW7
Linear, Star (P1/P2 enable)	OFF	OFF
Linear, Star (P1 disable)	OFF	ON
Linear, Star (P2 disable)	ON	OFF
Redundant Ring	ON	ON

In Redundant Ring mode, the Fiber Link Monitor function should also be enabled. Set SW5 to the **ON** position. For point-to-point topology with redundant fiber cables, set both converters to **Redundant Ring** mode with the correct slot time setting.

Note: Refer to the **Remote Fiber Diagnosis** section for instructions.

If an ICF-1280I converter is deployed at the beginning or at the end of the topology in Linear mode or Star mode, the unused port should be disabled. In such cases, we recommend using an ICF-1180I series converter. Please use the ICF-1180I series with Rev. 1.3, or higher versions to connect with the ICF-1280I series.

LED Indicators

There are 9 LED indicators on the front panel of the ICF-12801.

LED	Color	Description	Relay Status
PWR1/PWR2	Solid green	Power is on	Closed
	Off	Power is off, or power error condition exists	Open
Ready	Solid green	Baudrate is detected, converter is ready for communication	Closed
	Flashing green*	Fiber diagnosis is finished	Closed
	Flashing red*	Detecting baudrate.	Closed
	Flashing red and green*	Slotting time setting error	Closed
	Off	System power is off	Closed
P1 Level/ P2 Level	Green	Fiber Component Strength Normal	Closed
	Orange	Fiber Component Strength is at a critical level, and might soon be at an abnormal level.	Closed
	Red	Fiber Component strength has failed or fiber cable is too long.	Open
P1/P2 (Fiber)	Flashing/ solid green	Fiber port is receiving data	Closed
	Solid red*	Fiber cable linking to Tx is abnormal	Open
	Flashing red*	Fiber cable linking to Rx is abnormal	Open
	Off	Fiber in idle state	Closed
P3 (PROFIBUS)	Flashing green	PROFIBUS port is communicating	Closed
	Flashing red	Inner transceiver IC defective; PROFIBUS port data communication error; insufficient shielding of the bus cable; echo package timeout	Open
	Solid red	Echo package timeout, PROFIBUS UART character error	Open
	Off	PROFIBUS in idle state	Closed
Fault	Solid green	Fiber connections are working normally in Fiber Diagnosis mode	Closed
	Flashing red*	Fiber abnormality occurred in another segment	Closed
	Solid red*	Fiber abnormality occurred on this converter	Closed

If both power inputs experience an outage, the relay will become an open circuit for alarm purposes.

*Refer to the following table for troubleshooting.

Troubleshooting LED Indicators and Fiber Diagnosis

LED	Status	Description	Status/Troubleshooting
Ready	Flashing green	Fiber diagnosis finished	Check Fault LED; At least one converter is in Fiber Diagnosis mode; Check PROFIBUS master settings; Tx and Rx cables crossed
	Flashing red	Detecting baudrate	No PROFIBUS node; No PROFIBUS signal received; Tx and RX crossed over; Baudrate setting is incorrect.
	Flashing green/red	Slot time setting error	Recalculate the slot time; Set $TSDR \geq 11$; Set HAS = greatest PROFIBUS node address + 1; Check consistency of operation mode for DIP switch 6/7; Check consistency of Fiber Link Monitor Mode for DIP switch 5
Fault	Flashing red	Fiber abnormality occurred in another segment	Use Fiber Diagnosis on another converter that is not adjacent to this converter
	Solid red	Fiber abnormality occurred on this converter	Check P1 and P2 LEDs
P1/P2	Flashing red	Rx fiber cable abnormality	Check the Rx fiber cable connecting to this port*; Tx and Rx cables crossed over; Partner module is powered OFF or defective
	Solid red	Tx fiber cable abnormality	Check the fiber cable linking to Tx of this port*
P3	OFF	PROFIBUS is idle	Check the PROFIBUS device connection
	Flashing red	PROFIBUS side error	RS-485 cable is not terminated or only terminated at one end; Open bus cable; PROFIBUS D+ and D- crossed over; Short circuit on PROFIBUS cable; RS-485 driver is defective; Check slot time setting, baudrate, and operation mode

If the abnormality indicated by the LED disappears in Fiber Diagnosis mode, check the consistency of the DIP switch settings on all the converters.

If the Tx and Rx cables are both abnormal, the P1/P2 LED will shine red. Check the Rx cable first for troubleshooting.

*If the Fault LED, P1 LED, and P2 LED are all lit/flashing red simultaneously, the Tx and Rx cables of P1 and P2 may be crossed over.



ATTENTION

This is a Class 1 laser/LED product. Do not stare into the laser beam.

Fiber Signal Intensity Diagnosis

In some circumstances you may need to measure the receive level of fiber optic channels P1 and P2 with a voltmeter, which can be connected while the device is operating (doing so will not affect data transmission). The measurement can be taken with a voltmeter and read on a PLC that uses floating high impedance analog inputs, which allows you to do the following:

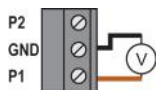

- The incoming optical power can be recorded for later measurement (e.g., to indicate aging or damage).
- Carry out a good/bad test (limit value).

You must use a high-resistance, ungrounded voltmeter to conduct the measurements, but whatever you do, don't connect the ground connector to the housing, since doing so could affect data transmission. In addition, the measuring cables must be less than 3 meters in length to meet EMC requirements. Refer to the diagrams below to estimate the quality of the bus traffic based on the receiving levels.

NOTE For a valid measurement, the partner ICF-1280I at the other end of the fiber-optic cable must send normal PROFIBUS frames. This can be recognized by the LED display of the partner ICF.

A number of different factors can affect the output voltages at the measurement sockets:

- The partner ICF-1280I's optical transmit power
- The optical transmitter and receiver's ambient temperature
- The transmission line attenuation
- The transmission rate that's in use

Keep in mind that these measurement sockets are not meant to replace a proper calibrated level measuring device that has a calibrated light source. The values obtained from the measurement sockets can only be used to classify the received optical signals into one of 4 categories:

- Good (normal operation, green), $3\text{ V} > U > 480\text{ mV}$
- Critical (optical link margin reduced, yellow), $330\text{ mV} \leq U \leq 480\text{ mV}$
- Bad (functionality not guaranteed, red), $U < 330\text{ mV}$
- Fiber cable unplugged, $U < 160\text{ mV}$

When taking measurements, use a standard ungrounded, high-resistance voltmeter. The internal resistance of the measurement sockets is approximately 30 kΩ.

- **Multi-mode: ICF-1280I-M-ST**

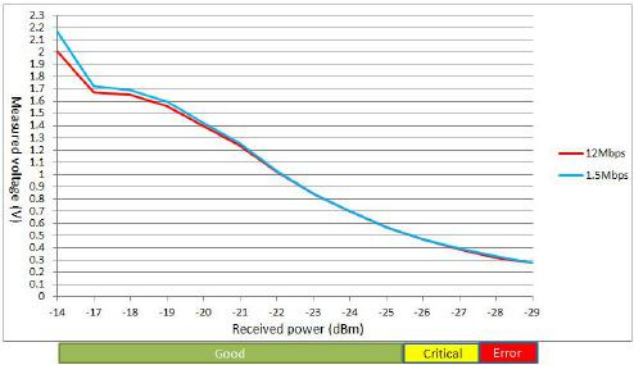

- **Single-mode: ICF-1280I-S-ST**

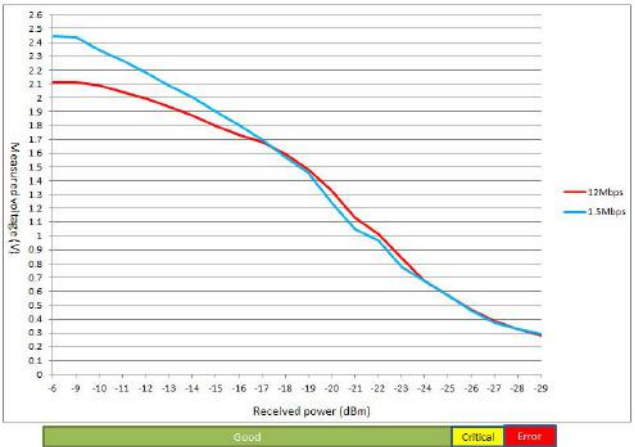

NOTE These charts are not suitable for use with a Remote Fiber Diagnosis test.

Specifications

PROFIBUS Communication	
PROFIBUS Interface	PROFIBUS DP Compliant with EN 50170
Number of Ports	1
Connector	DB9 female
Isolation Protection	2 kV
Baudrate	9.6, 19.2, 45.45, 93.75, 187.5, 500 kbps, 1.5, 3, 6, 12 Mbps
Auto Baudrate	Yes
Fiber Communication	
Connector type	ST
Number of Ports	2
Distance	Single-mode fiber: 45 km Multi-mode fiber: 4 km
Support Cable	Single-mode: 8.3/125, 8.7/125, 9/125 or 10/125 μm Multi-mode: 50/125, 62.5/125, or 100/140 μm
Wavelength	ICF-1280I-S: 1310 nm ICF-1280I-M: 820 nm
Tx Output	ICF-1280I-S: -7 dBm ICF-1280I-M: -14 dBm
Rx Sensitivity	ICF-1280I-S: -29 dBm ICF-1280I-M: -28 dBm
Link Budget	ICF-1280I-S: 21 dBm ICF-1280I-M: 14 dBm
Transmission	Half duplex
Signal delay time (any input/output)	< 6.5 tbit
Environmental Limits	
Operating Temperature	Standard Operating Temp: 0 to 60°C (32 to 140°F) Wide Operating Temp: -40 to 75°C (-40 to 167°F), for -T Models
Storage Temperature	-40 to 75°C (-40 to 167°F)
Ambient Relative Humidity	5 to 95% (non-condensing)
Atmospheric pressure	Up to 2000 m (795 hPa)
Note: Please contact Moxa if you require products guaranteed to function properly at higher altitudes.	
Power	
Input Power Voltage	12 to 48 VDC
Connector	Terminal block
Power Line Protection	IEC 6000-4-5 Level 3 (2 kV) Surge Protection
Power Polarity Protection	Protects against V+/V- reversal
Over-Current Protection	1.1 A
Power Consumption	370 mA max. (single-mode: 185 mA @ 24 VDC, multi-mode: 169 mA @ 24 VDC)
Relay Output	1 digital output relay to alarm (Normal: closed) Current carrying capacity: 2 A @ 30 VDC

Physical Characteristics	
Dimensions	39 × 115 × 70 mm
Material	Aluminum (1 mm)
Gross Weight	225 g
Regulatory Approvals	
Safety	UL 508
Hazardous Location	UL/cUL Class I, Division 2, Groups A, B, C, and D DNV.2.4 (not suitable for installation on a bridge) ATEX Zone 2: Ex nA nC IIC T4 Gc IECEX: IECEX UL 14.0094X IEC 60079-0:2011 Ed.6 IEC 60079-15:2010 Ed.4
EMC	CE; FCC Part 15, sub part B, Class A
EMI	EN 55032, Class A; EN 55024
EMS	EN 61000-4-2 (ESD), Level 2 EN 61000-4-3 (RS), Level 3 EN 61000-4-4 (EFT), Level 4 EN 61000-4-5 (Power Surge), Level 3 EN 61000-4-6 (CS), Level 3 EN 61000-4-8 (PFMF), Level 1
Freefall	IEC 60068-2-32
MTBF	792,085 hrs.
Green Product	RoHS, CRoHS, WEEE