

EDS-P206A-4PoE Series Hardware Installation Guide

Moxa EtherDevice Switch

Third Edition, April 2014



© 2014 Moxa Inc. All rights reserved.

P/N: 1802002060012

Overview

The EDS-P206A-4PoE series industrial Ethernet switches are entry-level industrial 6-port PoE Ethernet switches that support IEEE 802.3, IEEE 802.3u, and IEEE 802.3x, with 10/100M, full/half-duplex, MDI/MDIX auto-sensing, IEEE 802.3af, and IEEE 802.3at.

The EDS-P206A-4PoE series provides 24/48 VDC redundant power inputs that can be connected simultaneously to a live DC power source. The switches are available with a standard operating temperature range from 0 to 60°C, or with a wide operating temperature range from -40 to 75°C, and their IP30 metal housing makes them rugged enough for any harsh industrial environment.

To provide greater versatility for use with applications from different industries, the EDS-P206A-4PoE switches also allow users to enable or disable broadcast storm protection with DIP switches on the outer panel.

The EDS-P206A-4PoE switches can be easily installed on a DIN-Rail or in distribution boxes. The DIN-Rail mounting capability and IP30 metal housing with LED indicators make the plug-and-play EDS-P206A-4PoE switches reliable and easy to use.

NOTE Throughout this Hardware Installation Guide, we use **EDS** as an abbreviation for Moxa EtherDevice Switch:

EDS = Moxa EtherDevice Switch

Package Checklist

Your EDS is shipped with the following items. If any of these items are missing or damaged, please contact your customer service representative for assistance.

- Moxa EtherDevice™ Switch
- Hardware Installation Guide
- Warranty card

Features

High-wattage Power-over-Ethernet

- Up to 30 watts per PoE port
- Active circuit protection
- Auto disconnection for over-voltage or under-voltage
- Power consumption detection and classification

High Performance Network Switching Technology

- 10/100BaseT(X) (RJ45 connector), 100BaseFX (SC/ST connector, multi/single-mode)
- 10/100M, Full/Half-Duplex, MDI/MDIX auto-sensing
- IEEE 802.3/802.3u/802.3x
- Store and Forward switching process type, 1K address entries

Rugged Design

- Redundant dual 24/48 VDC power input
- Operating temperature range from 0 to 60°C, or extended operating temperature of -40 to 75°C for "T" models.
- IP30 metal housing
- DIN-Rail or panel mounting capability

EDS-P206A-4PoE (Standard) Panel Layouts

Front Panel View

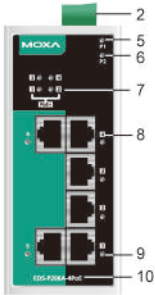

Top Panel View

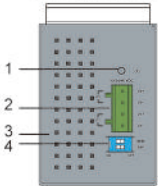

Rear Panel View

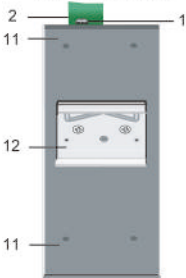

1. Grounding screw
2. Terminal block for power input P1/P2
3. Heat dissipation vents
4. DIP switches
5. Power input P1 LED
6. Power input P2 LED
7. PoE LED
8. 10/100BaseT(X) port
9. TP port's 10/100 Mbps LED
10. Model name
11. Screw hole for wall mounting kit
12. DIN-Rail kit

EDS-P206A-4PoE-M-SC/ST Panel Layouts

NOTE: The EDS-P206A-4PoE-S-SC/ST are identical in appearance to the EDS-P206A-4PoE-M-SC/ST.

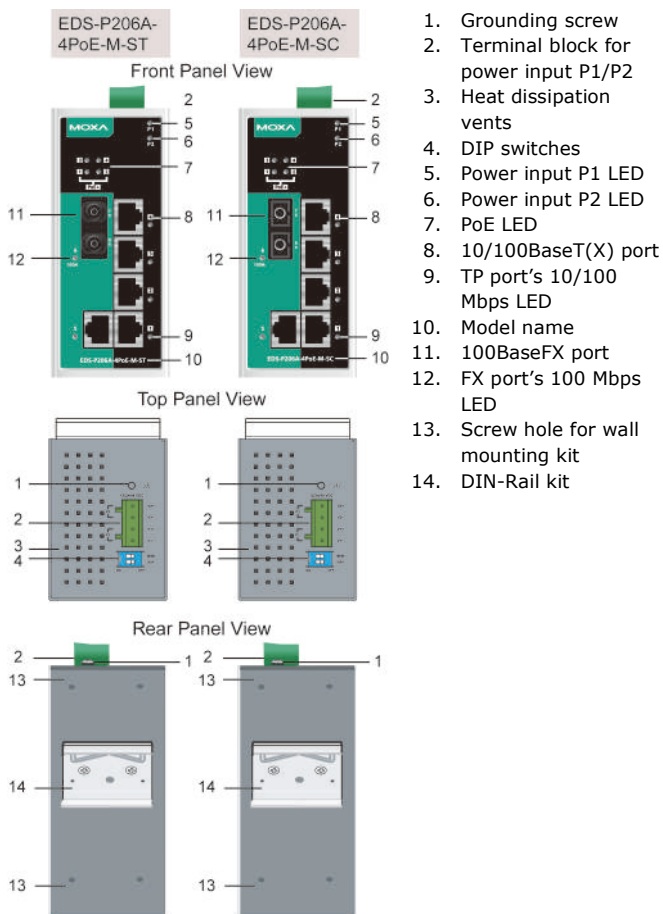

EDS-P206A-4PoE-MM-SC/ST Panel Layouts

NOTE: The EDS-P206A 4PoE-SS-SC/ST are identical in appearance to the EDS-P206A-4PoE- MM-SC/ST.

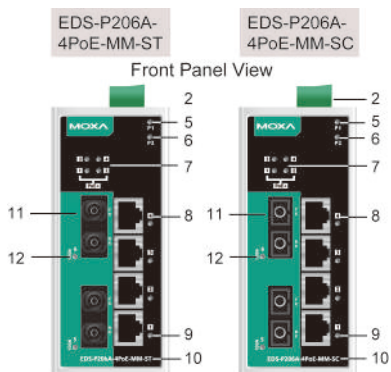

Top Panel View

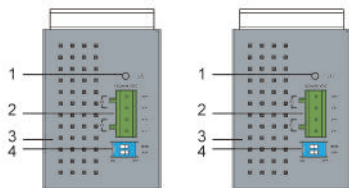

Rear Panel View

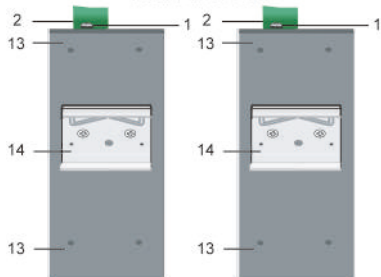

1. Grounding screw
2. Terminal block for power input P1/P2
3. Heat dissipation vents
4. DIP Switches
5. Power input P1 LED
6. Power input P2 LED
7. PoE LED
8. 10/100BaseT(X) port
9. TP port's 10/100 Mbps LED
10. Model name
11. 100BaseFX port
12. FX port's 100 Mbps LED
13. Screw hole for wall mounting kit
14. DIN-Rail kit

Mounting Dimensions

Unit = mm (inch)

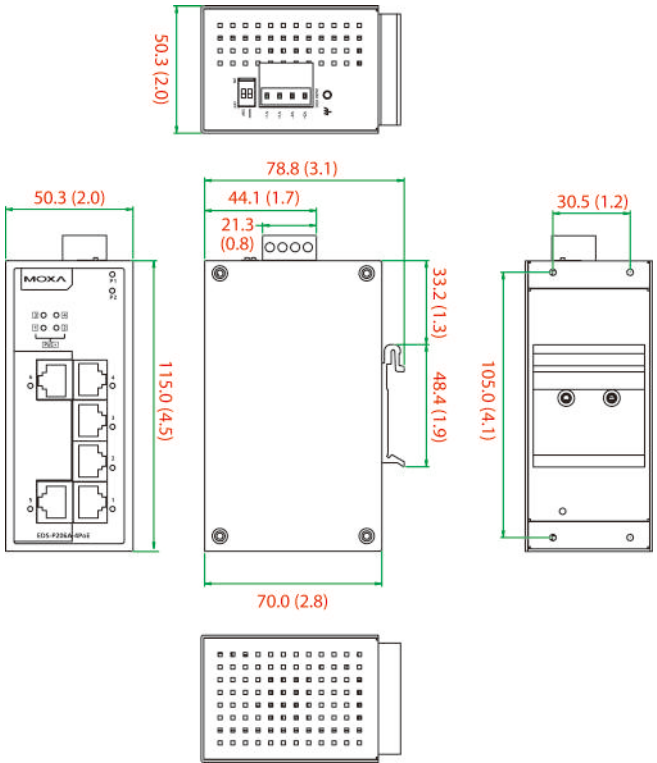

DIN-Rail Mounting

The aluminum DIN-Rail attachment plate should already be fixed to the back panel of the EDS when you take it out of the box. If you need to reattach the DIN-Rail attachment plate, make sure the stiff metal spring is situated towards the top, as shown in the figures below.

STEP 1: Insert the top of the DIN-Rail into the slot just below the stiff metal spring.

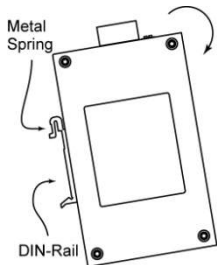

STEP 2: The DIN-Rail attachment unit will snap into place as shown below.

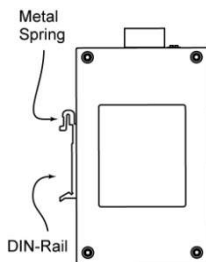

To remove the EDS from the DIN-Rail, reverse Steps 1 and 2 above.

Wall Mounting (optional)

For some applications, you will find it convenient to mount the EDS-P206A-4PoE on the wall, as shown in the following figures.

STEP 1: Remove the aluminum DIN-Rail attachment plate from the EDS-P206A-4PoE's rear panel, and then attach the wall mount plates as shown in the diagram at the right.

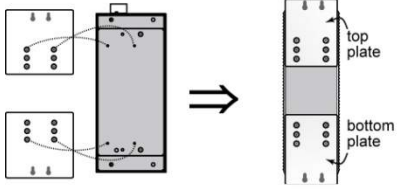

STEP 2: Mounting the EDS-P206A-4PoE on the wall requires 4 screws. Use the switch, with wall mount plates attached, as a guide to mark the correct locations of the 4 screws. The heads of the screws should be less than 6.0 mm in diameter, and the shafts should be less than 3.5 mm in diameter, as shown in the figure at the right.

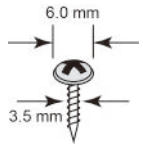

NOTE Before tightening the screws into the wall, make sure the screw head and shank size are suitable by inserting the screw into one of the keyhole-shaped apertures of the wall mounting plates.

Do not screw the screws in completely—leave about 2 mm to allow room for sliding the wall mount panel between the wall and the screws.

STEP 3: Once the screws are fixed in the wall, insert the four screw heads through the large parts of the keyhole-shaped apertures, and then slide the EDS-P206A-4PoE downwards, as indicated. Tighten the four screws for added stability.

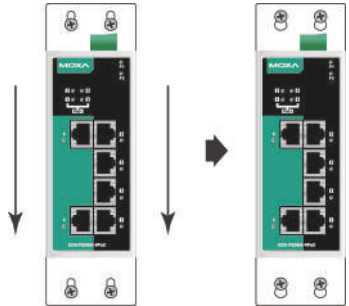

Wiring Requirements



WARNING

Safety First!

Turn the power off before disconnecting modules or wires. The correct power supply voltage is listed on the product label. Check the voltage of your power source to make sure that you are using the correct voltage. Do NOT use a voltage greater than what is specified on the product label.



WARNING

Safety First!

Calculate the maximum possible current in each power wire and common wire. Observe all electrical codes dictating the maximum current allowable for each wire size. If the current goes above the maximum ratings, the wiring could overheat, causing serious damage to your equipment.

You should also pay attention to the following points:

- Use separate paths to route wiring for power and devices. If power wiring and device wiring paths must cross, make sure the wires are perpendicular at the intersection point.
NOTE: Do not run signal or communications wiring and power wiring in the same wire conduit. To avoid interference, wires with different signal characteristics should be routed separately.
- You can use the type of signal transmitted through a wire to determine which wires should be kept separate. The rule of thumb is that wiring that shares similar electrical characteristics can be bundled together.
- Keep input wiring and output wiring separated.
- We strongly advise labeling the wiring to all devices in the system.

Grounding the EtherDevice Switch

Grounding and wire routing help limit the effects of noise due to electromagnetic interference (EMI). Run the ground connection from the ground screw to the grounding surface prior to connecting devices.



ATTENTION

This product is intended to be mounted to a well-grounded mounting surface such as a metal panel.

Wiring the Redundant Power Inputs

The top two contacts and the bottom two contacts of the 4-contact terminal block connector on the EDS's top panel are used for the EDS's two DC inputs. Top and front views of one of the terminal block connectors are shown here.

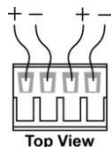

STEP 1: Insert the negative/positive DC wires into the V-/V+ terminals.

STEP 2: To keep the DC wires from pulling loose, use a small flat-blade screwdriver to tighten the wire-clamp screws on the front of the terminal block connector.

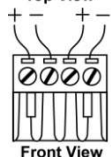

STEP 3: Insert the plastic terminal block connector prongs into the terminal block receptor, which is located on EDS's top panel.



ATTENTION

Before connecting the EtherDevice Switch to the DC power inputs, make sure the DC power source voltage is stable.

Communication Connections

The EDS-P206A-4PoE switches have 6, 7, or 8 10/100BaseT(X) Ethernet ports, and 2, 1, or 0 (zero) 100BaseFX multi/single-mode (SC/ST-type connector) fiber ports.

10/100BaseT(X) Ethernet Port Connection

10/100BaseT(X) ports located on the EDS's front panel are used to connect to Ethernet-enabled devices. Below we show pinouts for both MDI (NIC-type) ports and MDI-X (HUB/Switch-type) ports, and also show cable wiring diagrams for straight-through and cross-over Ethernet cables.

MDI Port Pinouts		MDI-X Port Pinouts		8-pin RJ45
Pin	Signal	Pin	Signal	
1	Tx+	1	Rx+	
2	Tx-	2	Rx-	
3	Rx+	3	Tx+	
6	Rx-	6	Tx-	

PoE 10/100BaseT(X) Ethernet Port Connection

PoE 10/100BaseT(X) ports located on the EDS switch's front panel are used to connect to PoE-enabled devices. The pinout follows the "Alternative A, MDI-X mode" of 802.3af/at standards. Please see the details in the following table.

PoE Port Pinout

Pin	Data	Power
1	Tx+	V-
2	Tx-	V-
3	Rx+	V+
6	Rx-	V+

8-pin RJ45

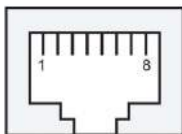

NOTE According to IEEE 802.3af/at standards, the PD shall be implemented to be insensitive to the polarity of the power supply and shall be able to operate per MDI mode and MDI-X mode. However, some PDs only support MDI mode or MDI-X mode only. The following figure shows how to select the correct cable between the PD and EDS-P206A-4POE.

RJ45 (8-pin) to RJ45 (8-pin) Straight-Through Cable Wiring

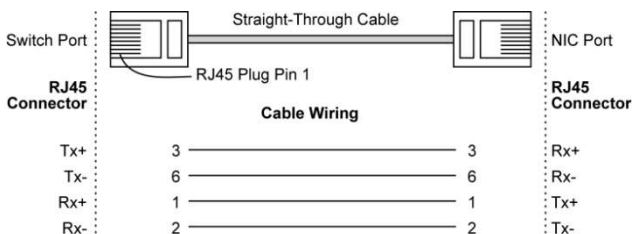

RJ45 (8-pin) to RJ45 (8-pin) Cross-Over Cable Wiring

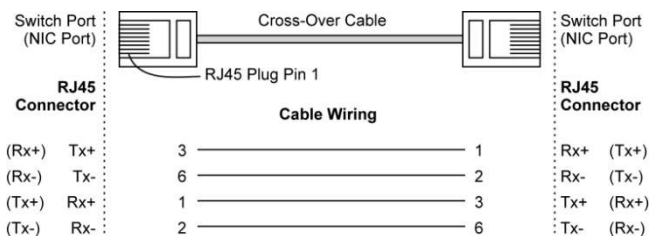

NOTE If the PD only supports MDI mode (V+, V+, V-, V- for pins 1, 2, 3, 6), choose a cross-over Ethernet cable to connect the PD and the EDS switch. If the PD only supports MDI-X mode (V-, V-, V+, V+ for pins 1, 2, 3, 6), choose a straight-through Ethernet cable between the PD and the EDS-P206-4PoE switch.

100BaseFX Ethernet Port Connection

The concept behind the SC/ST port and cable is straightforward. Suppose you are connecting devices I and II; contrary to electrical signals, optical signals do not require a circuit in order to transmit data. Consequently, one of the optical lines is used to transmit data from device I to device II, and the other optical line is used transmit data from device II to device I, for full-duplex transmission.

Remember to connect the Tx (transmit) port of device I to the Rx (receive) port of device II, and the Rx (receive) port of device I to the Tx (transmit) port of device II. If you make your own cable, we suggest labeling the two sides of the same line with the same letter (A-to-A and B-to-B, as shown below, or A1-to-A2 and B1-to-B2).

SC-Port Pinouts

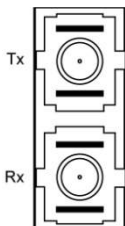

SC-Port to SC-Port Cable Wiring

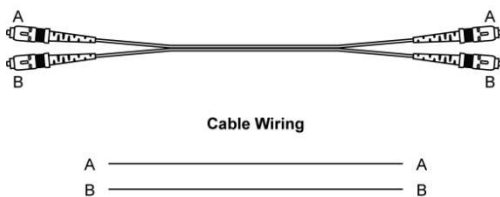

ST-Port Pinouts

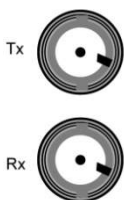

ST-Port to ST-Port Cable Wiring

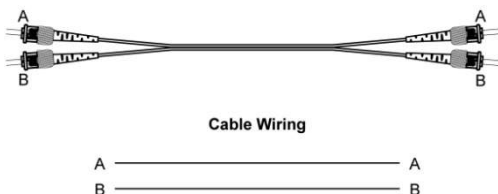

ATTENTION

This is a Class 1 Laser/LED product. To avoid causing serious damage to your eyes, do not stare directly into the Laser Beam.

Redundant Power Inputs

Both power inputs can be connected simultaneously to live DC power sources. If one power source fails, the other live source acts as a backup, and automatically supplies all of the EDS's power needs.

DIP Switch Settings

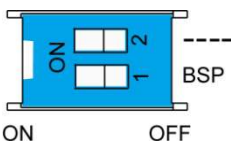

The default setting for each DIP Switch is OFF. The following table explains the effect of setting the DIP Switches to the ON positions.

DIP Switch	Setting	Description
-	-	Serves no function (reserved for future use).
BSP	ON	Enables broadcast storm protection
	OFF	Disables broadcast storm protection



ATTENTION

To actively update DIP switch settings, power off and then power on the EDS.

LED Indicators

The front panel of the EDS switches contains several LED indicators. The function of each LED is described in the following table.

LED	Color	State	Description
P1	AMBER	On	Power is being supplied to power input P1.
		Off	Power is not being supplied to power input P1.
P2	AMBER	On	Power is being supplied to power input P2.
		Off	Power is not being supplied to power input P2.
10/100	AMBER	On	TP port's 10 Mbps link is active.

		Blinking	Data is being transmitted at 10 Mbps.
		Off	TP Port's 10 Mbps link is inactive.
	GREEN	On	TP port's 100 Mbps link is active.
		Blinking	Data is being transmitted at 100 Mbps.
100M	GREEN	Off	TP Port's 100 Mbps link is inactive.
		On	FX port's 100 Mbps link is active.
		Blinking	Data is being transmitted at 100 Mbps.
PoE	AMBER	Off	FX port's link is inactive.
		On	Power is being supplied to Powered Device (PD)
		Off	Power is not being supplied to Powered Device (PD)

Auto MDI/MDI-X Connection

The Auto MDI/MDI-X function allows users to connect the EDS's 10/100BaseTX ports to any kind of Ethernet device, without needing to pay attention to the type of Ethernet cable being used for the connection. This means that you can use either a straight-through cable or cross-over cable to connect the EDS to Ethernet devices.

Dual Speed Functionality and Switching

The Moxa EtherDevice Switch's 10/100 Mbps switched RJ45 port auto negotiates with the connected device for the fastest data transmission rate supported by both devices. All models of Moxa EtherDevice Switch are plug-and-play devices, so that software configuration is not required at installation, or during maintenance. The half/full duplex mode for the switched RJ45 ports is user dependent and changes (by auto-negotiation) to full or half duplex, depending on which transmission speed is supported by the attached device.

Switching, Filtering, and Forwarding

Each time a packet arrives at one of the switched ports, a decision is made to either filter or forward the packet. Packets with source and destination addresses belonging to the same port segment will be filtered, constraining those packets to one port, and relieving the rest of the network from the need to process them. A packet with destination address on another port segment will be forwarded to the appropriate port, and will not be sent to ports where it is not needed. Packets that are used in maintaining the operation of the network (such as the occasional multi-cast packet) are forwarded to all ports. The EDS operates in the store-and-forward switching mode, which eliminates bad packets and enables peak performance to be achieved when there is heavy traffic on the network.

Switching and Address Learning

The EDS has an address table that can hold up to 1024 addresses, which makes it suitable for use with large networks. The address tables are self-learning, so that as nodes are added or removed, or moved from one segment to another, the EDS automatically keeps up with new node locations. An address-aging algorithm causes the least-used addresses to be deleted in favor of newer, more frequently used addresses. To reset the address buffer, power down the unit and then power it back up.

Auto-Negotiation and Speed Sensing

All of the EDS's RJ45 Ethernet ports independently support auto-negotiation for speeds in the 10BaseT and 100BaseTX modes, with operation according to the IEEE 802.3u standard. This means that some nodes could be operating at 10 Mbps, while at the same time, other nodes are operating at 100 Mbps. Auto-negotiation takes place when an RJ45 cable connection is made, and then each time a LINK is enabled. The EDS advertises its capability for using either 10 Mbps or 100 Mbps transmission speeds, with the device at the other end of the cable expected to advertise in a similar manner. Depending on what type of device is connected, this will result in agreement to operate at a speed of either 10 Mbps or 100 Mbps. If an EDS RJ45 Ethernet port is connected to a non-negotiating device, it will default to 10 Mbps speed and half-duplex mode, as required by the IEEE 802.3u standard.

Specifications

Technology		
Standards	IEEE 802.3 for 10BaseT, IEEE 802.3u for 100BaseT(X) and 100BaseFX, IEEE 802.3x for Flow Control IEEE 802.3af for PoE IEEE 802.3at for PoE+	
Processing Type	Store and Forward	
Flow Control	IEEE 802.3x flow control, back pressure flow control	
Interface		
RJ45 Ports	10/100BaseT(X) auto negotiation speed, F/H duplex mode, and auto MDI/MDI-X connection	
Fiber Ports	100BaseFX ports (SC/ST connector, multi/single-mode)	
LED Indicators	P1, P2 (Power), 10/100M (TP port), and 100M (fiber port), PoE	
DIP Switch	enable/disable broadcast storm protection	
Optical Fiber		
	100BaseFX	
	Multi-mode	Single-mode
Wavelength	1300 nm	1310 nm
Max. TX	-10 dBm	0 dBm
Min. TX	-20 dBm	-5 dBm
RX Sensitivity	-32 dBm	-34 dBm
Link Budget	12 dB	29 dB
Typical Distance	5 kma	40 kmc
	4 kmb	
Saturation	-6 dBm	-3 dBm
using [50/125µm, 800 MHz*km] cable		
using [62.5/125µm, 500 MHz*km] cable		
using [9/125 µm, 3.5 PS/(nm*km)] cable		

Power	
Input Voltage	24/48 VDC
Input Current	5.5/2.6 A
Connection	Removable 4-contact terminal block
Overload Current Protection	12 A
Reverse Polarity Protection	Present
Conformance to UL standards	Always use an "isolated power supply" to conform to the UL 508 standard.
Note: We strongly recommend using an isolated power supply with maximum output current of 7.5 A due to the power de-rating issue of the power supply at high operating temperatures. Moreover, without galvanic isolation between the redundant power inputs of this device, the V1+ and V2+ should use the same voltage.	
Physical Characteristics	
Housing	Metal, IP30 protection
Dimensions	50 x 115 x 70 mm
Weight	275 g
Installation	DIN-Rail Mounting, Wall Mounting (with optional kit)
Environmental Limits	
Operating Temperature	Standard models: 0 to 60°C (32 to 140°F) Wide temp. models: -40 to 75°C (-40 to 167°F)
Storage Temperature	-40 to 85°C (-40 to 185°F)
Ambient Relative Humidity	5 to 95% (non-condensing)
Regulatory Approvals	
EMI	FCC Part 15, CISPR (EN55022) class A
EMS	EN61000-4-2 (ESD), Level 3 EN61000-4-3 (RS), Level 3 EN61000-4-4 (EFT), Level 3 EN61000-4-5 (Surge), Level 3 EN61000-4-6 (CS), Level 3 EN61000-4-8, Level 5
Shock	IEC 60068-2-27
Freefall	IEC 60068-2-32
Vibration	IEC 60068-2-6
Warranty	
Time Period	5 years
Details	www.moxa.com/warranty

Technical Support Contact Information
www.moxa.com/support

Moxa Americas:

Toll-free: 1-888-669-2872

Tel: 1-714-528-6777

Fax: 1-714-528-6778

Moxa China (Shanghai office):

Toll-free: 800-820-5036

Tel: +86-21-5258-9955

Fax: +86-21-5258-5505

Moxa Europe:

Tel: +49-89-3 70 03 99-0

Fax: +49-89-3 70 03 99-99

Moxa Asia-Pacific:

Tel: +886-2-8919-1230

Fax: +886-2-8919-1231